

HEXAGON

LAB

APAVISA

HEXAGON  
LAB

APAVISA

## INDEX

P. 02-03	<b>Intro</b>
P. 04-09	<b>STARLINE:</b>
p. 05	BLACK natural
p. 07	WHITE natural
p. 09	BLUE natural
P. 10-15	<b>INTUITION:</b>
p. 11	WHITE Circle and Wave
p. 13	BLACK Circle
p. 15	Patterns
P. 16-23	<b>SOUTH:</b>
p. 17	GREY natural
p. 19	GREEN natural
p. 21	WHITE natural
p. 23	PINK natural
P. 24-27	<b>PUNTO CROCE:</b>
p. 25	BLACK Decor
p. 27	WHITE natural
P. 28-33	<b>ZINC:</b>
p. 29	GREEN Mix Decor and GREEN natural
p. 31	SILVER Single
p. 33	SILVER Mix Decor
P. 34-37	<b>NORTH DECOR:</b>
p. 35	BLACK decor
p. 37	SAND decor
P. 38-41	<b>NANOCONCEPT:</b>
p. 39	WHITE Mix natural
p. 41	GREY Mix natural
P. 42-45	<b>ALCHEMY:</b>
p. 43	BLUE natural
p. 45	WHITE natural
P. 46-51	<b>WIND:</b>
p. 47	IVORY natural
p. 49	GREY natural
p. 51	MOSS natural
P. 56-59	<b>Compilation</b>
p. 60	Anti-Slip values. Packing.

# HEXAGON

## LAB

In the heart of APAVISA a new concept of creativity vibrates. The design is in each beat, marking a fascinating rhythm that will capture you from the first moment. New shapes, new colours and new concepts come together to give meaning to unexplored spaces and creating a trend. Welcome to this trip through our heart.



En el corazón de APAVISA vibra un nuevo concepto de creatividad. El diseño está en cada latido marcando un ritmo fascinante que te atrapará desde el primer momento. Nuevas formas, nuevos colores y nuevos conceptos se aunan para dar sentido a los espacios por explorar creando tendencia. Bienvenido a este viaje por nuestro corazón.

# HEXAGON

## LAB



# STARLINE

COLLECTION







# STARLINE

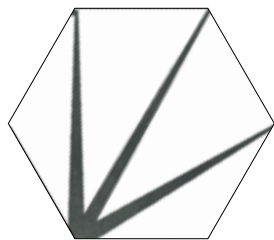

STARLINE WHITE  
natural G-7230



STARLINE BLACK  
natural G-7230



STARLINE BLUE  
natural G-7230



size:  
25x29  
cm

colors:  
03

finishes:  
natural

## ANTI-SLIP VALUES

Valores antideslizamiento

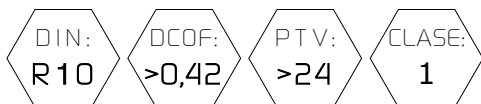

DIN:  
**R10**

DCOF:  
**>0,42**

PTV:  
**>24**

CLASE:  
**1**

DIN 51130 ANSI A 137.1 BS-7976 UNE-ENV 12633

NON rectified material. Minimum installation joint when fixing is 2 mm.  
Material NO rectificado. Junta mínima para su colocación de 2 mm.





# INTUITION

COLLECTION







# INTUITION

## PATTERNS



INTUITION WHITE  
natural G-7208



INTUITION WHITE  
1 stamp  
Circle G-7254



INTUITION WHITE  
1 stamp  
Wave G-7254

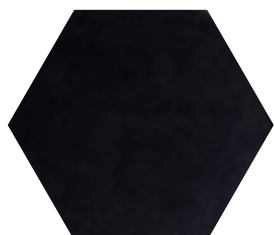

INTUITION BLACK  
natural G-7208



INTUITION BLACK  
1 stamp  
Circle G-7254



INTUITION BLACK  
1 stamp  
Wave G-7254



Available in all colors.  
*Disponibles en todos los colores.*

INTUITION Circle + INTUITION Wave.  
1 Pieze 6 Piezes

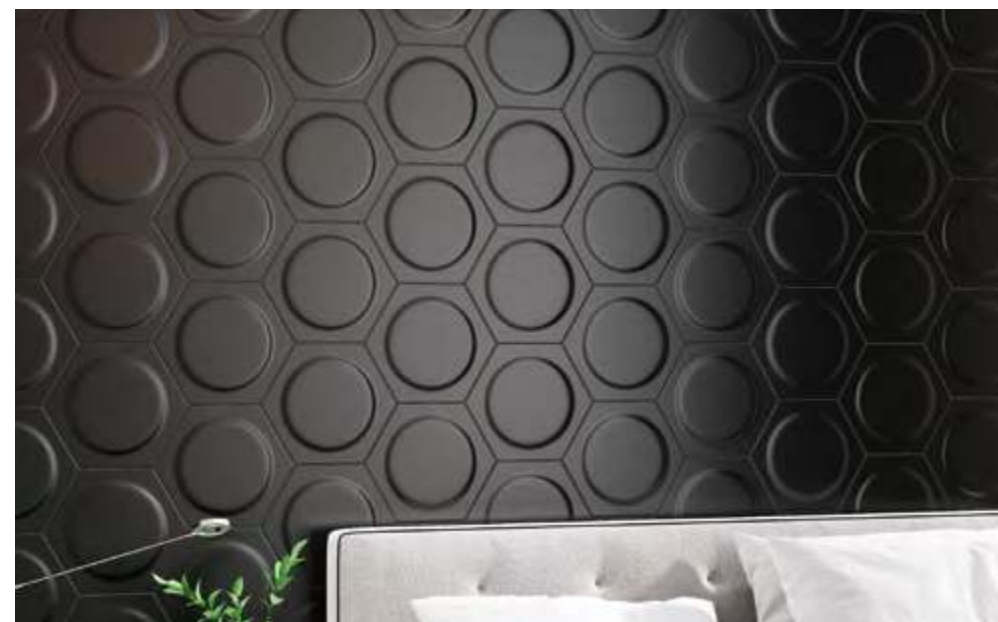

Available in all colors.  
*Disponibles en todos los colores.*

INTUITION Circle  
<15>

### ANTI-SLIP VALUES Valores antideslizamiento

size: 25x29 cm	colors: 02	stamps: 02	finishes: natural circle wave	DIN: R10	DCOF: >0,42	PTV: >24	CLASE: 1
----------------------	---------------	---------------	--	-------------	----------------	-------------	-------------

DIN 51130 ANSI A 137.1 BS-7976 UNE-ENV 12633

NON rectified material. Minimum installation joint when fixing is 2 mm.  
Material NO rectificado. Junta mínima para su colocación de 2 mm.

# SOUTH

COLLECTION







◻ SOUTH GREEN natural









# SOUTH

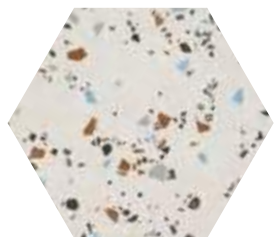

SOUTH WHITE  
natural G-7230

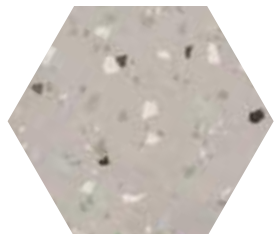

SOUTH GREY  
natural G-7230

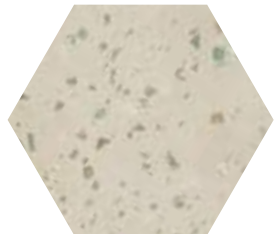

SOUTH GREEN  
natural G-7230



SOUTH PINK  
natural G-7230



size:  
25x29  
cm

colors:  
04

finishes:  
natural

## ANTI-SLIP VALUES

Valores antideslizamiento

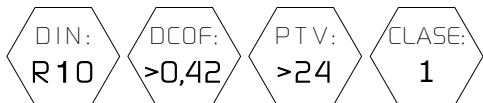

DIN:  
R10

DCOF:  
>0,42

PTV:  
>24

CLASE:  
1

DIN 51130 ANSI A 137.1 BS-7976 UNE-ENV 12633

NON rectified material. Minimum installation joint when fixing is 2 mm.  
Material NO rectificado. Junta mínima para su colocación de 2 mm.





PUNTO  
CROCE  
COLLECTION





# PUNTO CROCE



PUNTO CROCE  
BLACK decor G-7230



patterns:  
21 mix



PUNTO CROCE  
WHITE natural G-7230

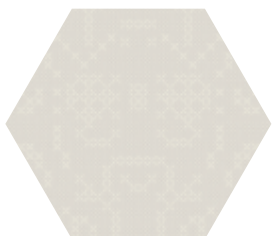

patterns:  
21 mix



## ANTI-SLIP VALUES Valores antideslizamiento

size: 25x29 cm	colors: 02	patterns: 21 mix	finishes: natural decor	DIN: <b>R10</b> DIN 51130	DCOF: <b>&gt;0,42</b> ANSI A 137.1	PTV: <b>&gt;24</b> BS-7976	CLASE: <b>1</b> UNE-ENV 12633
----------------------	---------------	---------------------	-------------------------------	---------------------------------	--	----------------------------------	-------------------------------------

NON rectified material. Minimum installation joint when fixing is 2 mm.  
Material NO rectificado. Junta mínima para su colocación de 2 mm.





# ZINC

COLLECTION









# ZINC

## SINGLE

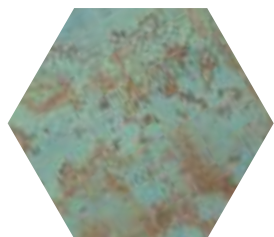

ZINC GREEN  
natural G-7230



ZINC SILVER  
1 stamp  
SINGLE G-7274

Natural finish ANTI-SLIP VALUES  
Valores antideslizamiento acabado Natural

size:  
25 x 29  
cm

colors:  
02

stamps:  
01

finishes:  
natural  
single

DIN:  
R10

DCOF:  
>0,42

PTV:  
>24

CLASE:  
1

DIN 51130

ANSI A 137.1

B5-7976

UNE-ENV 12633

## MIX DECOR



ZINC GREEN  
3 stamps  
Mix decor G-7254



ZINC SILVER  
3 stamps  
Mix decor G-7274



size:  
25 x 29  
cm

colors:  
02

stamps:  
03

finishes:  
Mix decor



ZINC SILVER Mix decor

NON rectified material. Minimum installation joint when fixing is 2 mm.  
Material NO rectificado. Junta mínima para su colocación de 2 mm.



NORTH  
DECOR  
COLLECTION





# NORTH DECOR

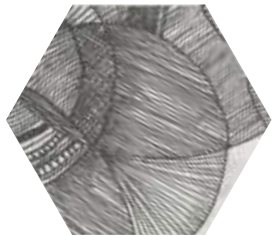

**NORTH BLACK**  
decor G-7230

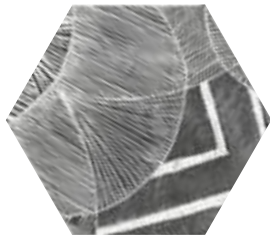

**patterns:**  
32 mix

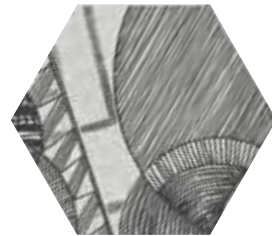

**NORTH SAND**  
decor G-7230  
Nonslip G-7254



**patterns:**  
32 mix



## ANTI-SLIP VALUES Valores antideslizamiento

finishes:

size: 25x29 cm	colors: 02	patterns: 32 mix	Decor	DIN: <b>R10</b> DIN 51130	DCOF: <b>&gt;0,42</b> ANSI A 137.1	PTV: <b>&gt;24</b> BS-7976	CLASE: <b>1</b> UNE-ENV 12633
			Nonslip	DIN: <b>R11</b> DIN 51130	DCOF: <b>&gt;0,42</b> ANSI A 137.1	PTV: <b>&gt;36</b> BS-7976	CLASE: <b>3</b> UNE-ENV 12633

NON rectified material. Minimum installation joint when fixing is 2 mm.  
Material NO rectificado. Junta mínima para su colocación de 2 mm.



NORTH SAND Decor



# NANOCONCEPT

COLLECTION



# NANOCONCEPT



**NANOCONCEPT**  
GREY Mix G-7230  
Nonslip G-7254

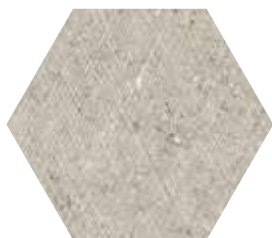

patterns:  
3 decors mix



**NANOCONCEPT**  
WHITE Mix G-7230  
Nonslip G-7254



patterns:  
3 decors mix



finishes:

## ANTI-SLIP VALUES

Valores antideslizamiento

size: 25x29 cm	colors: 0 2	patterns: 3 mix	natural	DIN: <b>R10</b> DIN 51130	DCOF: <b>&gt;0,42</b> ANSI A 137.1	PTV: <b>&gt;24</b> BS-7976	CLASE: <b>1</b> UNE-ENV 12633
			Nonslip	DIN: <b>R11</b> DIN 51130	DCOF: <b>&gt;0,42</b> ANSI A 137.1	PTV: <b>&gt;36</b> BS-7976	CLASE: <b>3</b> UNE-ENV 12633

*NON rectified material. Minimum installation joint when fixing is 2 mm.*  
Material NO rectificado. Junta mínima para su colocación de 2 mm.





# ALCHEMY

COLLECTION





# ALCHEMY

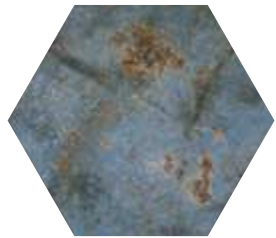

ALCHEMY BLUE  
natural G-7230

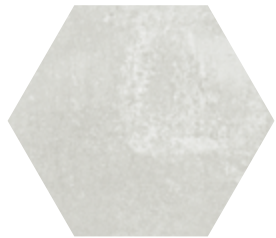
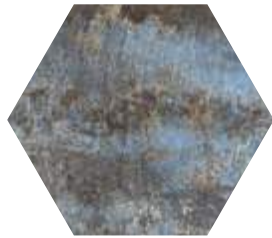
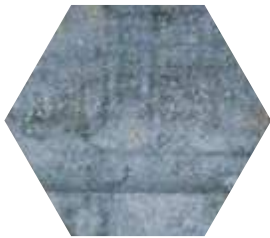

ALCHEMY WHITE  
natural G-7230

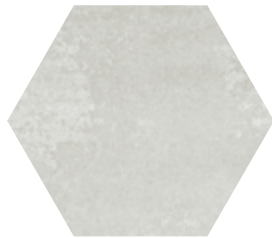
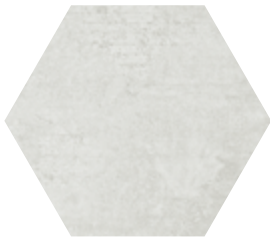

## ANTI-SLIP VALUES Valores antideslizamiento

DIN: <b>R10</b>	DCOF: <b>&gt;0,42</b>	PTV: <b>&gt;24</b>	CLASE: <b>1</b>
DIN 51130	ANSI A 137.1	BS-7976	UNE-ENV 12633

size: 25x29 cm	colors: 0 2	finishes: natural
----------------------	----------------	----------------------

NON rectified material. Minimum installation joint when fixing is 2 mm.  
Material NO rectificado. Junta mínima para su colocación de 2 mm.





WIND  
COLLECTION

















# WIND

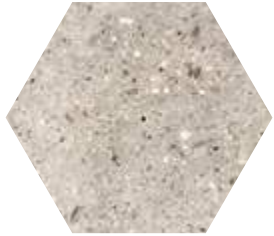

WIND IVORY  
natural G-7230  
Nonslip G-7254

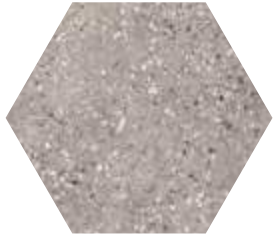

WIND GREY  
natural G-7230  
Nonslip G-7254

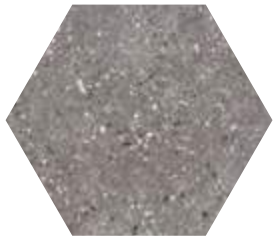

WIND MOSS  
natural G-7230

finishes:

size: 25x29 cm

colors: 03

patterns: mix

natural

## ANTI-SLIP VALUES

Valores antideslizamiento

DIN: <b>R10</b>	DCOF: <b>&gt;0,42</b>	PTV: <b>&gt;24</b>	CLASE: <b>1</b>
DIN 51130	ANSI A 137.1	BS-7976	UNE-ENV 12633

Nonslip	DIN: <b>R11</b>	DCOF: <b>&gt;0,42</b>	PTV: <b>&gt;36</b>	CLASE: <b>3</b>
	DIN 51130	ANSI A 137.1	BS-7976	UNE-ENV 12633



WIND MOSS natural

NON rectified material. Minimum installation joint when fixing is 2 mm.  
Material NO rectificado. Junta mínima para su colocación de 2 mm.

STARLINE Pg.04-09



STARLINE BLUE  
natural G-7230

STARLINE BLACK  
natural G-7230

STARLINE WHITE  
natural G-7230

PUNTO CROCE Pg.24-27



PUNTO CROCE  
BLACK  
decor G-7230

patterns:  
21 mix

PUNTO CROCE  
WHITE  
natural G-7230

patterns:  
21 mix

INTUITION Pg.10-15



INTUITION WHITE  
Natural G-7208

INTUITION WHITE  
1 stamp  
Circle G-7254

INTUITION WHITE  
1 stamp  
Wave G-7254

ZINC MIX DECOR Pg.28-33



ZINC SILVER  
3 stamps  
Mix decor G-7274

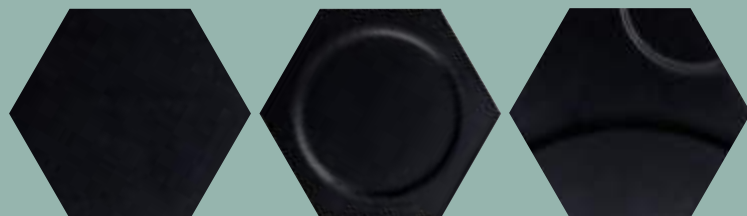

INTUITION BLACK  
Natural G-7208

INTUITION BLACK  
1 stamp  
Circle G-7254

INTUITION BLACK  
1 stamp  
Wave G-7254



ZINC GREEN  
3 stamps  
Mix decor G-7254

SOUTH Pg.16-23

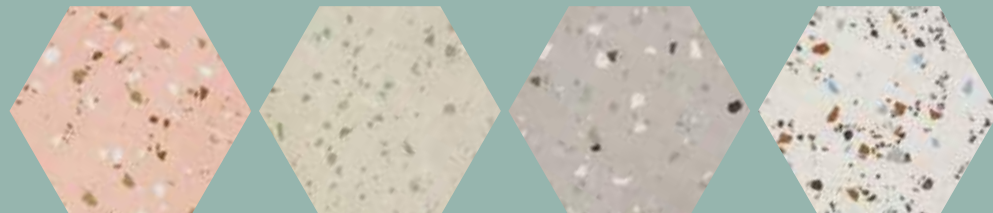

SOUTH PINK  
natural G-7230

SOUTH GREEN  
natural G-7230

SOUTH GREY  
natural G-7230

SOUTH WHITE  
natural G-7230

ZINC SINGLE Pg.28-31 ZINC NATURAL Pg.28

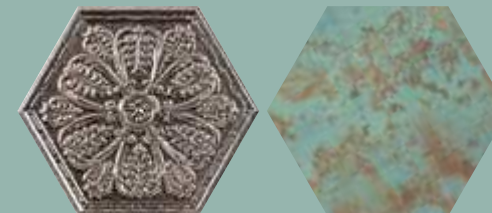

ZINC SILVER  
1 stamp  
SINGLE G-7274

ZINC GREEN  
natural G-7230



## NORTH Pg.34-37

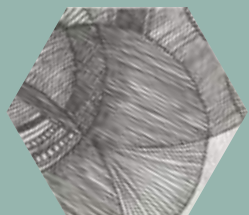

NORTH BLACK  
decor G-7230

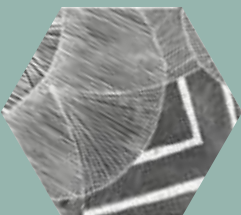

patterns:  
32 mix



NORTH SAND  
decor G-7230  
Nonslip G-7254



patterns:  
32 mix

## WIND P.64-71

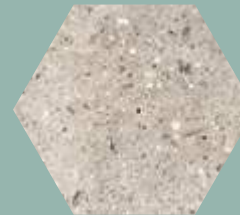

WIND IVORY  
natural G-7230  
Nonslip G-7254

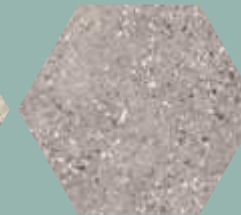

WIND GREY  
natural G-7230  
Nonslip G-7254

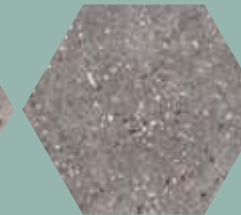

WIND MOSS  
natural G-7230

## NANOCONCEPT P.38-41

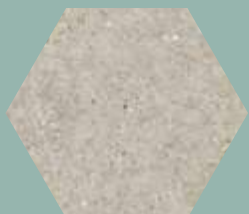

NANOCONCEPT  
GREY Mix G-7230  
Nonslip G-7254

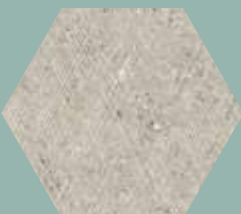

patterns:  
3 decors mix



NANOCONCEPT  
WHITE Mix G-7230  
Nonslip G-7254



patterns:  
3 decors mix

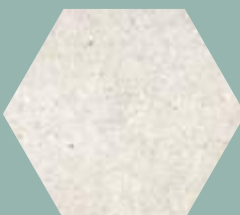

## ALCHEMY P.46-51

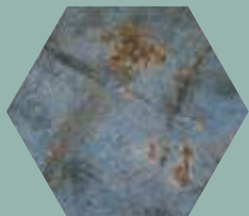

ALCHEMY BLUE  
natural G-7230

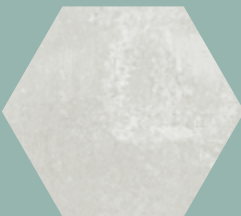

ALCHEMY WHITE  
natural G-7230

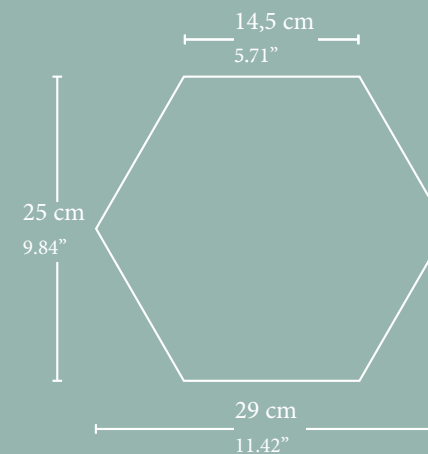

*NON rectified material. Minimum installation joint when fixing is 2 mm.  
Material NO rectificado. Junta mínima para su colocación de 2 mm.*

## Packing HEXAGON Lab

SIZE	Size cm		Size "		Box/ Pallet	Pzs/ Box	M2/ Box	M2/ Pallet	SQF/ Box	SQF/ Pallet	Kg/ Pallet	Kg/ Box	Kg/ Piece
	25	29	9,84	11,42									
25x29 Hexagon	25	29	9,84	11,42	48	17	0,935	44,88	10,06	483,09	1060	21,767	1,271

The product may have variations in tone due to the manufacturing process. Ask about specific product before delivery. Photographs may present color variations with respect to the actual product. Ask about specific product before delivery.

El producto puede presentar variaciones de tono derivadas de proceso de fabricación. Realizar consulta de un producto específico antes del suministro.

Las fotografías editadas pueden presentar variaciones cromáticas respecto al producto real. Realizar consulta de un producto específico antes del suministro.



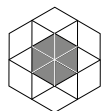

HEXAGON

LAB

APAVISIA PORCELANICO S.L. assumes no liability for any printing errors. The technical characteristics contained in this catalog are mean values of our products. To carry out any orders that are requested consultations with the technical characteristics of the particular model to APAVISIA PORCELANICO S.L.

All features and specifications are based on information available at the time of printing this catalog and may be changed without

**APAVISIA**  
[www.apavisa.com](http://www.apavisa.com)

Ctra. Castellón – San Juan de Moró, hm.7,5  
12130 SAN JUAN DE MORÓ (Castellón) Spain  
Tel. +34 964 701 120 - Export Fax +34 964 701 067 - Fax Nacional 964 701 195  
[info@apavisa.com](mailto:info@apavisa.com)

*APAVISIA PORCELANICO S.L. no asume ninguna responsabilidad por posibles errores de impresión. Las características técnicas que constan en el presente catálogo son valores medios de nuestros productos. Para la realización de cualquier pedido se solicita que sean consultadas las características técnicas del modelo en concreto a APAVISIA PORCELANICO S.L. Todas las características y especificaciones técnicas están basadas en la información disponible en el momento de la impresión del presente catálogo y podrán ser modificadas sin previo aviso, de acuerdo a las circunstancias del mercado, innovaciones tecnológicas y/o cualquier otro factor, sin incurrir en ningún tipo de responsabilidad.*





HEXAGON  
LAB

**APAVISA**  
[www.apavisa.com](http://www.apavisa.com)

Ctra. Castellón – San Juan de Moró, hm.7,5 - 12130 SAN JUAN DE MORÓ (Castellón) Spain  
Tel. +34 964 701 120 - Export Fax +34 964 701 067 - Fax Nacional 964 701 195 - [info@apavisa.com](mailto:info@apavisa.com)

