

MADE IN ITALY. MADE TO EXCEL.

**MARVEL | STONE**

 **atlas concorde**



MADE IN ITALY. MADE TO EXCEL.

 **atlas concorde**

**COLOURED BODY PORCELAIN TILES . GRES PORCELLANATO COLORATO IN MASSA**  
Grès cérame coloré dans la masse | Durchgefärbtes Feinsteinzeug  
Gres porcelánico coloreado en masa | Керамический гранит окрашенный в массе

**WHITE-BODY WALL TILES . RIVESTIMENTI IN PASTA BIANCA**  
Revêtements en pâte blanche | Weißscherbige Wandfliesen  
Revestimientos en pasta blanca | Настенная плитка из белой глины

**MARVEL | STONE**

DISCOVER THIS NEW  
**MUST-HAVE LUXURY**

SPERIMENTATE IL NUOVO  
LUSSO ESSENZIALE



**MARBLE + STONE**  
INSPIRATION

**atlas concorde**

EXPÉRIMENTEZ LE NOUVEAU LUXE ESSENTIEL  
ENTDECKEN SIE DEN NEUEN PUREN LUXUS  
LA EXPERIENCIA DE LA NUEVA ESENCIA DEL LUJO  
ОЩУТИТЕ НОВУЮ ЛАКОНИЧНУЮ РОСКОШЬ



**MARBLE**  
INSPIRATION

**STONE**  
INSPIRATION

## MEANT TO BE TOGETHER

ISPIRAZIONE MARMO + ISPIRAZIONE PIETRA:  
UNA COESSENZA NATURALE

**T**he superb style of these luminously sophisticated marble-look tiles for floors and walls meets the essential elegance of surfaces that interpret the minimalistic simplicity of stone. Marvel Stone is a project focused on luxurious contemporary design, with a wide and extensive range of coordinated marble and stone-effect tiles where beauty meets the versatility of porcelain stoneware and the practicality of ceramic.

**L'**estrema classe di pavimenti e rivestimenti effetto marmo, luminosi e sofisticati, incontra l'eleganza essenziale di superfici che interpretano pietre dall'aspetto sobrio e minimale. Marvel Stone è un progetto orientato al design di lusso contemporaneo con un'ampia e profonda gamma coordinata di superfici effetto marmo e pietra che combina ricercatezza estetica con la versatilità del gres porcellanato e la praticità della ceramica.



La grande classe de sols et revêtements muraux effet marbre, lumineux et sophistiqués, épouse l'élégance sobre de surfaces qui interprètent des pierres à l'aspect sobre et minimaliste. Marvel Stone est un projet orienté au design de luxe contemporain, qui offre une gamme coordonnée, large et profonde, de surfaces effet marbre et pierre, sachant allier à la recherche esthétique, l'éclectisme du grès cérame et la praticité de la céramique. Die Wertigkeit von Boden- und Wandbelägen in Marmoroptik mit heller, edler Ausstrahlung trifft auf die schlichte Eleganz von Oberflächen, die dem Naturstein nachempfunden sind und durch ihr nüchternes, minimalistisches Design bestechen. Marvel Stone ist ein Projekt, das modernes Luxusdesign verkörpert. Es besteht aus einem umfassenden und tiefgreifenden Sortiment von aufeinander abgestimmten Oberflächen in Marmor- und Natursteinoptik und vereint eine edle Optik mit der Vielseitigkeit des Feinsteinzeugs und Zweckmäßigkeit der Keramik. Los pavimentos y revestimientos efecto mármol, luminosos y sofisticados, encuentran la elegancia esencial en sus superficies plasmando piedras de aspecto sobrio y sencillo. Marvel Stone es un proyecto dirigido al diseño de lujo contemporáneo con un amplio y coordinado abanico de superficies efecto mármol y piedra que combina el refinamiento estético con la versatilidad del gres porcelánico y la funcionalidad de la cerámica. Благородство напольной и настенной плитки под мрамор, яркой и изысканной, сочетается с элегантностью строгих и минималистических фактур камня. Marvel Stone – это роскошный современный проект, который вообрал в себя богатую гамму плиток под мрамор и камень, соединив утонченную эстетику с функциональностью керамогранита и практичностью настенной керамики.

atlas concorde

INSPIRATION MARBRE+INSPIRATION PIERRE : UNE CO-ESSENCE NATURELLE  
MARMOR + NATURSTEIN ALS INSPIRATIONSQUELLEN: EIN NATÜRLICHE WESENSVERWANDTSCHAFT  
INSPIRACIÓN MÁRMOL+INSPIRACIÓN PIETRA: UNA COESENCIA DE LA NATURALEZA  
ФАКТУРА МРАМОРА + ФАКТУРА КАМНЯ: НАТУРАЛЬНАЯ ГАРМОНИЯ



TELEMENT CONTEMPORAIN, LUXUEUX ET ÉLÉANT  
 SO ZEITGEMÄSS, SO STILVOLL, SO ELEGANT  
 CONTEMPORÁNEO, REFINADO, ELEGANTE  
 ТАК СОВРЕМЕННО, ТАК РОСКОШНО, ТАК ЭЛЕГАНТНО

## SO CONTEMPORARY, SO CLASSY, SO ELEGANT

COSÌ CONTEMPORANEO, COSÌ LUSSUOSO, COSÌ ELEGANTE

**E**xtraordinary surfaces inspired by marble and stone are placed harmoniously together; exciting combinations of materials are paired with a palette of hues in gloss and matt finishes. Marvel Stone allows you to create areas where the elegance of prestigious surfaces inspired by marble is re-interpreted in a contemporary key by introducing the minimalistic simplicity look of stone.

**S**orprendenti superfici ispirate al marmo e alla pietra convivono dando vita a interessanti accostamenti di materiali, abbinamenti di tonalità e di finiture lucide e opache. Con Marvel Stone è possibile realizzare ambienti in cui l'eleganza di prestigiose superfici effetto marmo è reinterpretata in chiave contemporanea grazie alla contaminazione con un effetto pietra dal look minimal ed essenziale.



Des surfaces surprenantes qui s'inspirent du marbre et de la pierre, réunies pour donner naissance à d'intéressantes associations de matières, ainsi qu'à des assortiments de couleurs et de finitions mates et brillantes. Marvel Stone permet de réaliser des espaces où l'élégance de surfaces prestigieuses effet marbre est réinterprétée en clé contemporaine, grâce à la contamination effet pierre au look essentiel et minimaliste. Ungewöhnlichen Oberflächen, in denen die Optik von Marmor und Naturstein verschmilzt, erzeugen ein interessantes Zusammenspiel aus Materialien, Farbtönen und Glanz-Matt-Effekten. Mit Marvel Stone lassen sich Räume gestalten, in denen die edle Eleganz der Marmoroptik auf die minimalistische Schlichte der Natursteinoptik trifft und in eine zeitgemäße Interpretation umgesetzt wird. Sorprendentes superficies inspiradas en mármoles y piedras conviven para dar vida a interesantes mezclas de materiales, combinación de tonalidades y acabados brillantes y opacos. Con Marvel Stone es posible realizar entornos en los que la elegancia de prestigiosas superficies efecto mármol está reinterpretada de manera contemporánea gracias a la integración con el efecto de la piedra de aspecto sencillo y esencial. Удивительные поверхности под мрамор и камень рожают интересные сочетания материалов, тонов и отделок – блестящих и матовых. С помощью коллекции Marvel Stone можно создать интерьеры, в которых престижная фактура мрамора звучит необыкновенно современно благодаря соседству с минималистическим рисунком камня.



The unique splendour of floor and wall tiles inspired by precious marble are matched by the rigorous simplicity of stone-effect surfaces.

*Allo splendore unico di pavimenti e rivestimenti ispirati a marmi preziosi si aggiunge il carattere rigoroso ed essenziale di superfici effetto pietra.*

La splendeur unique des sols et des revêtements muraux inspirés de marbres précieux s'allie au caractère rigoureux et essentiel des surfaces effet pierre. In die einzigartige Pracht von Boden- und Wandbelägen, die kostbaren Marmorsorten nachempfunden sind, fließt der strenge und schlichte Charakter der Oberflächen in Natursteinoptik ein. Al esplendor único de pavimentos y revestimientos inspirados en mármoles preciosos se le añade el carácter riguroso y esencial de superficies efecto piedra. Уникальное великолепие напольной и настенной плитки с имитацией ценных пород мрамора дополняется строгой простотой камня.

atlas concorde

LA DERNIÈRE FRONTIÈRE DU LUXE  
DER JÜNGSTE TREND IN SACHEN LUXUS  
LA ÚLTIMA FRONTERA DEL LUJO  
ПОСЛЕДНИЙ РУБЕЖ РОСКОШИ

MARVEL STONE

PORCELAIN & WALLTILES

#FLOORANDWALL

## THE LAST FRONTIER OF LUXURY

L'ULTIMA FRONTIERA DEL LUSSO

**P**orcelain stoneware floor tiles and white clay wall tiles with beautiful luxurious surfaces, elaborate swirls and veins and sophisticated tonalities realistically evoke the elegance of chic marble.

*P*avimenti in gres porcellanato e rivestimenti in pasta bianca evocano con realismo marmi eleganti e di tendenza, con superfici dall'estetica lussuosa, ricche di venature decise e tonalità sofisticate.

Les sols en grès cérame et les revêtements muraux en pâte blanche évoquent, avec réalisme, des marbres élégants et de tendance, grâce à leurs surfaces à l'esthétisme luxueux, riches en veinures uniques et en teintes sophistiquées. Bodenbeläge aus Feinsteinzeug und Wandbeläge aus weißscherbiger Keramik geben beeindruckend realistisch durch edle Oberflächen mit markanten Aderungen und erlesenen Farbnuancen das Erscheinungsbild eleganter, trendiger Marmorsorten wieder. Pavimentos de gres porcelánico y revestimientos de pasta blanca evocan con realismo mármoles elegantes y de moda, con superficies de estética lujosa, ricas en vetas de carácter decidido y tonalidades sofisticadas. Напольный керамогранит и настенная плитка из белой глины с точностью воспроизводят эlegantный рисунок мрамора с четкими прожилками и изысканными цветовыми нюансами.

# MARVELLOUS AND CLASSY MARBLE INSPIRATIONS

LO CHARME RAFFINATO ED ELEGANTE DELL'EFFETTO MARMO

atlas concorde

LE CHARME RAFFINÉ ET ÉLÉANT DE L'EFFET MARBRE  
DER CHARME UND DIE ELEGANZ DER MARMOROPTIK  
EL ENCANTO REFINADO Y ELEGANTE DE EFECTO MÁRMOL  
ЭЛЕГАНТНЫЙ ШАРМ ФАКТУРЫ МРАМОРА

Carefully selected natural materials enliven porcelain stoneware surfaces inspired by marble with an assertively stylish character for undeniably elegant interior designs. Exclusively precious materials are used in the Marvel project to create spaces where the chic luxury of marble-look tiles meets the architectural purity of stone-effect surfaces.

Una curata selezione di riferimenti naturali dà vita a superfici in gres porcellanato effetto marmo dal carattere deciso, ricercato e raffinato per una progettazione d'interni d'indiscussa eleganza. Essenze ricercate ed esclusive arricchiscono il progetto Marvel per la realizzazione di spazi dove il lusso e il prestigio dell'effetto marmo si fondono con la purezza architettonica dell'aspetto pietra.

01

CAR  
RARA  
PURE

02

BIAN  
CODOL  
OMITE

03

NERO  
MAR  
QUINA

04

BARD  
IGLIO  
GREY

05

CREA  
MPRE  
STIGE

Des matériaux d'inspiration naturelle soigneusement sélectionnés qui donnent naissance à des surfaces en grès cérame ayant un effet marbre recherché, raffiné et de grand caractère, pour une conception d'intérieur d'une indiscutable élégance. Des essences recherchées et exclusives enrichissent le projet Marvel pour la réalisation d'espaces où le luxe et le prestige de l'effet marbre se fondent à la pureté architecturale de l'aspect pierre. Eine gepflegte Auswahl an Nachempfndungen natürlicher Vorbilder lässt Oberflächen aus Feinsteinzeug in markanter, edler Marmoroptik für Innenraumgestaltungen von unbestrittener Eleganz entstehen. Die exklusiven Materialien im Projekt Marvel ermöglichen die Realisierung von Raumkonzepten, in denen die luxuriöse Ausstrahlung der Marmoroptik mit der nüchternen Schlichtheit der Natursteinoptik verschmilzt. Una cuidadosa selección de referencias naturales dan vida a superficies de gres porcelánico efecto mármol de carácter decidido, exquisito y refinado para un diseño de interiores de indiscutable elegancia. Esencias refinadas y exclusivas enriquecen el proyecto Marvel para realizar espacios donde el lujo y el prestigio de efecto mármol se funden con la pureza arquitectónica del aspecto piedra. Аккуратно подобранные природные образцы стали прообразом для создания изысканного «мраморного» керамогранита, способного ярко украсить пространства своей исключительной элегантностью. Эксклюзивная фактура материалов проекта Marvel дает возможность выстроить элитные интерьеры, в которых утонченная роскошь мрамора гармонично сплетается с благородной простотой камня.

**120X120**

47<sup>1</sup>/<sub>4</sub>"x47<sup>1</sup>/<sub>4</sub>"

Carrara Pure  
Bianco Dolomite

XL

HONED FINISH

## A WIDE SELECTION OF SIZES

UN'AMPIA SELEZIONE DI FORMATI

Une vaste sélection de formats  
Eine breite Auswahl an Formaten  
Amplia selección de formatos  
Богатый ассортимент форматов

**120X240**

47<sup>1</sup>/<sub>4</sub>"x94<sup>1</sup>/<sub>2</sub>"

Carrara Pure  
Bianco Dolomite

XL

**75X75**

29<sup>1</sup>/<sub>2</sub>"x29<sup>1</sup>/<sub>2</sub>"

**30X60**

11<sup>3</sup>/<sub>4</sub>"x23<sup>5</sup>/<sub>8</sub>"

**60X60**

23<sup>5</sup>/<sub>8</sub>"x23<sup>5</sup>/<sub>8</sub>"

**75X150**

29<sup>1</sup>/<sub>2</sub>"x59"

**45X90**

17<sup>3</sup>/<sub>4</sub>"x35<sup>3</sup>/<sub>8</sub>"

The brilliant reflections of high-gloss, honed finish reproduce, to maximum effect, the wonderful sheen of cutting-edge marble. With the wide range of porcelain stoneware tile sizes, the collection is open to contemporary living of great visual impact.

Una lucidissima finitura lappata dalle molteplici specchiature brillanti richiama con estrema cura e notevole realismo la meravigliosa lucentezza di marmi di tendenza. Un'ampia gamma di formati in gres porcellanato apre la collezione a spazi contemporanei di grande suggestione visiva.

## BRIGHT MARBLE- LOOK TILES IN EXQUISITE HONED FINISHES

LUMINOSO EFFETTO MARMO  
PER SPLENDENTI FINITURE  
LAPPATE



UN EFFET MARBRE LUMINEUX POUR DE SPLENDIDES FINITIONS POLIES  
HELLE MARMOROPTIK FÜR ERLESENE GELÄPTE OBERFLÄCHEN  
LUMINOSO EFECTO MÁRMOL PARA RESPLANDECIENTES ACABADOS LAPEADOS  
УТОЧНЕННАЯ ФАКТУРА МРАМОРА НА ЯРКИХ ЛАППАТИРОВАННЫХ ПОВЕРХНОСТЯХ

Une finition polie très brillante aux multiples surfaces miroitantes rappelle, avec un très grand soin et un remarquable réalisme, la merveilleuse brillance des marbres de tendance. Une vaste gamme de formats en grès cérame ouvre la collection pour des espaces contemporains de grande suggestion visuelle. Eine glänzende geläppte Oberfläche mit Spiegeleffekten knüpft eindrücklich und erstaunlich realistisch an den prächvollen Glanz trendiger Marmorsorten an. Durch die breite Auswahl an Formaten lassen sich mit dieser Kollektion aus Feinsteinzeug zeitgemäße Raumkonzepte mit ausdrucksstarker Optik gestalten. Acabado lapeado esplendente de múltiples espejos brillantes evoca con gran delicadez y notable realismo el maravilloso brillo de los mármoles de moda. Un amplio abanico de formatos de gres porcelánico abre la colección a espacios contemporáneos de gran sugestión visual. Гладкая лаппатированная поверхность, на которой эффектно играют блики, с точностью передает удивительную яркость трендовых сортов мрамора. Широкая гамма форматов керамогранита делает коллекцию идеальной для современных пространств со стильной благородной атмосферой.

## HONED FINISH

Porcelain stoneware has an incredibly high-gloss reflective surface with the fine details of a natural material.

*Il gres porcellanato lappato presenta una superficie straordinariamente lucida e specchiante arricchita dai raffinati dettagli della materia naturale.*

Le grès cérame poli présente une surface extraordinairement brillante et miroitante, enrichie des détails raffinés de la matière naturelle. Das geläppte Feinsteinzeug weist eine außergewöhnlich glänzende, spiegelnde Oberfläche auf, die durch die lebendigen Details des natürlichen Vorbilds bereichert ist. El gres porcelánico lapeado presenta una superficie extraordinariamente brillante y resplandeciente enriquecida de refinados detalles de la materia natural. Лаппатированный керамогранит обладает яркой зеркальной поверхностью, на которой стильно выступают детали рисунка природного мрамора.

# atlas concorde



## MARVEL STONE

PORCELAIN TILES

## MATT FINISH

*Matt surfaces accurately evoke the beauty of marble to define spaces with an exciting contemporary feel, bringing a natural stylishness to interior design projects.*

*La superficie matt evoca con realismo l'estetica della materia d'ispirazione e delinea spazi dal deciso carattere contemporaneo, conferendo una classe naturale all'interior design.*

La surface mate évoque avec réalisme l'esthétisme de la matière d'inspiration et crée des espaces au caractère très contemporain, en conférant une classe innée au design d'intérieur. Die matte Oberfläche, die das natürliche Vorbild in einer realistischen Optik wiedergibt, eignet sich für ausgesprochen moderne Raumkonzepte und verleiht Innenraumgestaltungen eine natürliche Wertigkeit. La superficie matt evoca con realismo la estética de la materia de inspiración y delinea espacios de carácter contemporáneo decidido, dando una clase natural al diseño de interiores. Матовая поверхность, реалистично воспроизводящая фактуру природного мрамора, формирует современный характер интерьера, придавая ему естественное благородство.

60X60  
23<sup>5</sup>/<sub>8</sub>"x23<sup>5</sup>/<sub>8</sub>"

45X90  
17<sup>3</sup>/<sub>4</sub>"x35<sup>3</sup>/<sub>8</sub>"

30X60  
11<sup>3</sup>/<sub>4</sub>"x23<sup>5</sup>/<sub>8</sub>"

# atlas concorde

# NATURAL PERFECTION FOR PRECIOUS WALLS

PREZIOSI RIVESTIMENTI DALLA PERFEZIONE NATURALE



50X110  
19<sup>5</sup>/<sub>8</sub>"x43<sup>1</sup>/<sub>4</sub>"

40X80  
15<sup>3</sup>/<sub>4</sub>"x31<sup>1</sup>/<sub>2</sub>"

atlas concorde

REVÊTEMENTS PRÉCIEUX D'UNE PERFECTION NATURELLE  
WERTIGE WANDBELÄGE VON NATÜRLICHER PERFEKTION  
PREZIOSOS RIVESTIMENTOS DE PERFECCIÓN NATURAL  
НАТУРАЛЬНОЕ СОВЕРШЕНСТВО НАСТЕННЫХ ПОКРЫТИЙ

**B**rilliant white-body wall tiles with reflective gloss finish faithfully replicate the refined beauty, sheen and graphic patterns of marble, creating carefully crafted surfaces with natural swirls and veins.

**B**rillanti rivestimenti in pasta bianca, dalla finitura lucida e specchiante, riproducono con fedeltà la raffinatezza estetica e la profondità grafica di brillanti essenze marmo, per superfici curate fin nei minimi dettagli e arricchite da una trama di venature naturali.

01

CAR  
RARA  
PURE

02

BIAN  
CODOL  
OMITE

03

NERO  
MAR  
QUINA

04

BARD  
IGLIO  
GREY

05

CREA  
MPRE  
STIGE

Les revêtements muraux en pâte blanche, de finition brillante et miroitante, reproduisent fidèlement le raffinement esthétique et la profondeur graphique des brillantes essences du marbre, pour des surfaces soignées dans les moindres détails et enrichies d'une trame de veinures naturelles. Glänzende Wandbeläge aus weißscherbiger Keramik mit spiegelnder Oberfläche geben getreu das edle Erscheinungsbild und die tiefgründige Optik des Marmors wieder und ermöglichen Inszenierungen, deren Vollkommenheit sich durch das Spiel der markanten Aderungen bis ins Detail offenbart. Revestimientos brillantes de pasta blanca, de acabado brillante y resplandeciente, reproducen fielmente la estética refinada y la profundidad gráfica de brillantes esencias mármol, para superficies acabadas minuciosamente y enriquecidas con una trama de venas naturales. Настенная плитка из белой глины с зеркально-блестящей поверхностью точно воспроизводит изысканность и глубину рисунка мрамора, благодаря чему покрытия, украшенные натуральными прожилками, выглядят утонченно и ухоженно.



UNE DÉCORATION D'INTÉRIEUR D'UN ESTHÉTISME IMPECCABLE  
 EINE INNENRAUMDEKORATION VON TADELLOSER ÄSTHETIK  
 DECORACIÓN DE INTERIORES DE ESTÉTICA IMMACULADA  
 ЭСТЕТИЧЕСКИ БЕЗУПРЕЧНЫЙ ДЕКОР ИНТЕРЬЕРА



The possibilities of the marble-look wall tiles are complemented by a refined range of coordinated mosaic tiles in a selection of colours, finishes and sizes, for spaces of great visual impact. A meticulous quest for beauty, with marble as an inspiration, is the core of a refined ornamental proposal reflecting the most advanced trends in interior design.

La potenzialità estetica dei rivestimenti effetto marmo è accentuata da una raffinata gamma di mosaici coordinati in diversi colori, finiture e dimensioni, per spazi dal forte impatto visivo. Da una minuziosa ricerca estetica che valorizza l'ispirazione marmo prende vita una raffinata proposta ornamentale in linea con le più evolute tendenze della decorazione d'interni.



## COMPREHENSIVE RANGE OF INTERIOR DESIGN ELEMENTS

UNA DECORAZIONE D'INTERNI DALL'ESTETICA IMPECCABILE



La potenzialité esthétique des revêtements muraux effet marbre est exaltée par une gamme raffinée de mosaïques dans différentes couleurs, finitions et dimensions coordonnées, pour des espaces à fort impact visuel. Une recherche esthétique minutieuse qui valorise l'inspiration du marbre donne naissance à un choix ornamental raffiné, en accord avec les dernières tendances de la décoration d'intérieur. Ein raffiniertes Sortiment an abgestimmten Mosaiken in verschiedenen Farben, Oberflächen und Größen erhöht das Gestaltungspotential der Wandbeläge in Marmoroptik und ermöglicht ausdrucksstarke Raumkonzepte. Aus einer Designstudie zur Akzentuierung der Marmorinterpretation entstand ein Dekor, das die neuesten Tendenzen in der Innenraumdekoratation aufgreift. La potencialidad estética de los revestimientos efecto mármol está intensificada por un refinado abanico de mosaicos coordinados de diferentes colores, acabados y tamaños para espacios de fuerte impacto visual. A partir de una cuidadosa búsqueda estética que valoriza la inspiración del mármol nace una propuesta refinada ornamental en concordancia con las más evolucionadas tendencia de decoración de interiores. Эстетический потенциал настенной плитки под мрамор возрастает благодаря изысканной гамме мозаики разных цветов, размеров и поверхностей, позволяющей создавать эффектные интерьеры. Кропотливое изучение эстетики мрамора привело к разработке богатой палитры декоративных элементов, отражающих самые передовые тенденции оформления пространств.

Classy stone-effect tiles determine rigorous stylishness in designer floor and wall tiles, combined with the precious luxury of marble-look surfaces.

*Un raffinato effetto pietra detta lo stile rigoroso di pavimenti e rivestimenti di design, incontrando il lusso prezioso di superfici dal look marmo.*

Un effet pierre raffiné dicte le style rigoureux des sols et des revêtements muraux de design, en épousant le luxe précieux des surfaces effet marbre. Eine edle Natursteinoptik diktiert den strengen Stil von Design-Boden- und Wandbelägen, die auf die luxuriöse Anmutung von Oberflächen im Marmorlook stoßen. Refinado efecto piedra dicta el estilo riguroso de pavimentos y revestimientos de diseño, encontrando el lujo precioso de superficies de aspecto mármol. Изысканная фактура камня диктует строгий стиль полов и стен, сочетаясь с роскошными поверхностями под мрамор.

atlas concorde

L'ÉMOTION ESSENTIELLE DES SURFACES EFFET PIERRE  
DAS INTENSIVE ERLEBEN VON OBERFLÄCHEN IN NATURSTEINOPTIK  
SUPERFICIES DE INTENSAS EMOCIONES EFECTO PIEDRA  
ПРОСТЫЕ ЭМОЦИИ ОТ КАМЕННЫХ ФАКТУР

MARVEL STONE

PORCELAIN & WALLTILES

#FLOORANDWALL

# THE ESSENTIAL EMOTIONS OF STONE-EFFECT SURFACES

L'EMOZIONE ESSENZIALE DI SUPERFICIE EFFETTO PIETRA

**A** range of surfaces in porcelain stoneware and white-body wall tiles to interpret the essential look of stylish contemporary stone, for interior and exterior design projects where beauty meets reliability.

*Una gamma di superfici in gres porcellanato e rivestimenti in pasta bianca interpreta l'aspetto essenziale di pietre contemporanee dal carattere raffinato, per progetti d'architettura di interni ed esterni in cui si incontrano estetica e affidabilità.*

Une gamme de surfaces en grès cérame et de revêtements muraux en pâte blanche, qui interprète l'aspect essentiel des pierres contemporaines au caractère raffiné, pour des projets d'architecture d'intérieur et d'extérieur qui allient esthétique et fiabilité. Eine Auswahl an Oberflächen aus Feinsteinzeug und Wandbelägen aus weißscherbiger Keramik, die der minimalistischen Optik moderner Natursteine nachempfunden sind, ermöglicht Gestaltungsprojekte für Innen- und Außenbereiche, die eine schöne Optik mit hoher Zuverlässigkeit vereinen. Abanico de superficies de gres porcelánico y revestimientos de pasta blanca que interpreta el aspecto esencial de piedras contemporáneas de carácter refinado, ideal para proyectos de arquitectura de interiores y exteriores donde se encuentran estética y fiabilidad. Гамма напольных керамогранитных плиток и настенных плиток из белой глины дает современную интерпретацию лаконичной фактуре камня, позволяя красиво и безопасно оформлять внутренние и наружные пространства.

# AN INSPIRED SELECTION OF STONE-EFFECT TILES

UNA RAFFINATA GAMMA DI SUPERFICI EFFETTO PIETRA



UNE GAMME RAFFINÉE DE SURFACES EFFET PIERRE  
EINE RAFFINIERTE AUSWAHL AN OBERFLÄCHEN IN NATURSTEINOPTIK  
REFINADO AVANICO DE SUPERFICIES EFECTO PIEDRA  
ИЗЫСКАННАЯ ГАММА ПЛИТОК ПОД КАМЕНЬ

**S**tone-look porcelain stoneware with matt finish and a smooth velvety touch to suggest natural polished stone with all its details and slight surface imperfections. The play of colour, minute irregularities, natural nuances and subdued personality of stone are replicated with surprising realism.

*Il gres porcellanato effetto pietra presenta una finitura matt, liscia e morbida al tatto, che evoca con estrema naturalezza le pietre spazzolate, mantenendone i dettagli e le lievi irregolarità di superficie. Il sorprendente realismo ricalca cromatismi, movimenti finissimi e sfumature naturali di pietre dalla personalità sobria e discreta.*

01

CLAU  
ZETTO  
WHITE

02

DES  
ERT  
BEIGE

03

CARD  
OSO  
ELEGANT

04

BASAL  
TINA  
VOLCANO

Le grès cérame effet pierre présente une finition mate, lisse et douce au toucher, qui évoque les pierres brossées avec un grand naturel, en en maintenant les détails et les légères irrégularités superficielles. Le réalisme surprenant reproduit les teintes, la fine trame des veinures et les nuances naturelles de pierres au caractère sobre et discret. Das Feinsteinzeug in Natursteinoptik weist eine matte, glatte Oberfläche mit weicher Haptik auf, die gebürsteten Natursteinen sehr natürlich nachempfunden ist und die detailreiche, leicht unregelmäßige der Oberfläche perfekt wiedergibt. Die außergewöhnlich realistische Interpretation spiegelt die Farben, feinen Bewegungen und natürlichen Strukturen schlichter Natursteine wider. El gres porcelánico efecto piedra presenta un acabado matt, liso y suave al tacto, trayendo a la memoria con máxima naturalidad las piedras cepilladas, manteniendo sus detalles y las tenues irregularidades de superficie. El sorprendente realismo calca cromatismos, movimientos finos y matices naturales de piedra de personalidad sobria y discreta. Керамогранит под камень имеет матовую, мягкую на ощупь поверхность, которая имитирует детали рисунка и легкие неровности шлифованных камней. С изумительным реализмом воспроизведены окраски, оттенки, цветовые переходы благородно-простого по виду природного материала.

# HI-TOUCH AND CLASSY MATT SURFACE

MORBIDA E RAFFINATA  
SUPERFICIE MATT

**S**one-effect porcelain stoneware with subdued charm and natural elegance is offered in a velvety matt finish and numerous formats to design spaces of any size and in any time scale.

*Il gres porcellanato effetto pietra dal fascino sobrio e dall'eleganza naturale è proposto nella morbida finitura matt in numerosi formati che permettono di progettare spazi di qualsiasi dimensione e orizzonte progettuale.*

Le grès cérame effet pierre au charme sobre et à l'élégance naturelle est proposé dans une douce finition mate et dans de nombreux formats qui permettent de concevoir des espaces de toutes dimensions, quel que soit le style recherché. Das Feinsteinzeug in Natursteinoptik mit schlichtem Charme und natürlicher Eleganz wird in der weichen Mattausführung in zahlreichen Formaten angeboten, die ein unglaubliches Gestaltungspotenzial für alle Planungserfordernisse bieten. El gres porcelánico efecto piedra de encanto sobrio y de elegancia natural, se propone con acabado matt de varios formatos con el fin de diseñar espacios de diferentes tamaños y llevar a cabo cualquier posibilidad de proyecto. Строгий и элегантный керамогранит под камень предложен с мягкой матовой поверхностью в многочисленных форматах, которые дают возможность проектировать пространства любых размеров и форм.

SURFACE MATE DOUCE ET RAFFINÉE  
WEICHE UND EDLE OBERFLÄCHE IN MATTOPTIK  
SUPERFICIES MATT SUAVES Y REFINADAS  
МЯГКАЯ МАТОВАЯ ПОВЕРХНОСТЬ

120X120

47<sup>3</sup>/<sub>4</sub>"x47<sup>3</sup>/<sub>4</sub>"

Clauzetto white  
Cardoso Elegant  
Basaltina Volcano

XL

## RANGE OF MATT FINISH TILES

GAMMA FORMATI IN FINITURA MATT

Gamme des formats en finition mate  
Auswahl an Formaten in Mattoptik  
Abanico para los formatos de acabado matt  
Гамма форматов с матовой поверхностью

120X240

47<sup>3</sup>/<sub>4</sub>"x94<sup>1</sup>/<sub>2</sub>"

Clauzetto white  
Cardoso Elegant  
Basaltina Volcano

XL

75X75

29<sup>1</sup>/<sub>2</sub>"x29<sup>1</sup>/<sub>2</sub>"

30X60

11<sup>3</sup>/<sub>4</sub>"x23<sup>5</sup>/<sub>8</sub>"

60X60

23<sup>5</sup>/<sub>8</sub>"x23<sup>5</sup>/<sub>8</sub>"

75X150

29<sup>1</sup>/<sub>2</sub>"x59"

45X90

17<sup>3</sup>/<sub>4</sub>"x35<sup>3</sup>/<sub>8</sub>"

# EXCEPTIONAL OUTDOOR TILES OF PURE CLASS

ECCELLENTI ESTERNI  
DALL'ELEGANZA ESSENZIALE

**T**he solidity of stone is revived in the porcelain stoneware surfaces with minute bush-hammering textures for high technical performance in damp or outdoor areas. Two-centimetre thick outdoor wall tiles combine the natural beauty of the simple stone effect with high strength, anti-slip features, and are easy to dry-lay on gravel or grass.

**L**a matericità della pietra rivive nella superficie in gres porcellanato strutturato, con una micro bocciardatura, per elevate prestazioni tecniche in ambienti umidi e in outdoor. Le pavimentazioni per esterni in 2 cm di spessore uniscono l'estetica naturale a effetto pietra minimal a proprietà di resistenza, antiscivolo, facilità di applicazione nella posa a secco su ghiaia o erba.

DES EXTÉRIEURS EXCELLENTS À L'ÉLÉGANCE ESSENTIELLE  
WERTIGE AUSSENBEREICHE VON SCHLICHTER ELEGANZ  
EXCELENTES EXTERIORES DE ELEGANCIA ESENCIAL  
ЛАКОНИЧНЫЕ И ЭЛЕГАНТНЫЕ НАРУЖНЫЕ ПРОСТРАНСТВА

TEXTURED FINISH

**30X60**  
11<sup>3</sup>/<sub>4</sub>" x 23<sup>5</sup>/<sub>8</sub>"

OUTDOOR PAVING ± 20 MM

**60X120**  
23<sup>5</sup>/<sub>8</sub>" x 47<sup>1</sup>/<sub>4</sub>"

**60X60**  
23<sup>5</sup>/<sub>8</sub>" x 23<sup>5</sup>/<sub>8</sub>"

La matière de la pierre revisitée dans la surface en grés cérame structuré, avec un micro bouchardage pour des performances techniques élevées dans des milieux humides et en plein air. Les carrelages pour extérieurs, avec une épaisseur de 2 cm, épousent l'esthétique naturelle et minimale de l'effet pierre à des propriétés de résistance, d'antidérapant et de facilité d'application dans la pose à sec sur gravier ou gazon. Der starke Materialcharakter des Natursteins entfaltet sich in der strukturierten, fein gehämmerten Oberfläche aus Feinsteinzeug mit herausragenden technischen Eigenschaften für feuchte Umgebungen und Outdoor-Bereiche. Die Bodenbeläge für Außenbereiche in der 2cm starken Ausführung vereinen eine natürlich anmutende, minimalistische Natursteinoptik mit guter Abriebbeständigkeit, Rutschfestigkeit und einfacher Verlegung auf Kies oder Gras. La esencia material de la piedra vuelve a revivir en la superficie del gres porcelánico estructurado, con un micro abujardado, para máximos rendimientos técnicos en ambientes húmedos y al aire libre. La pavimentación de exteriores de 2 cm de grosor unen la estética natural de efecto piedra simple con propiedades de resistencia, antideslizamiento facilitando su colocación en seco en grava o hierba. Красивая суть камня оживает в структурных керамогранитных плитках с микробучардированной поверхностью, которая обеспечивает высокие эксплуатационные показатели во влажных интерьерах и на улице. Уличные плитки 2-х сантиметровой толщины соединили натуральный вид камня с такими характеристиками как стойкость, противоскольжение, простота сухой укладки на гравий или траву.

PAROIS SOPHISTIQUÉES POUR UN STYLE NATUREL ET CONTEMPORAIN  
ELEGANTE WÄNDE FÜR EINE MODERNE NATÜRLICHKEIT  
PAREDES SOFISTICADAS PARA UNA NATURALEZA CONTEMPORÁNEA  
ИЗЫСКАННЫЕ СТЕНЫ ДЛЯ СОВРЕМЕННОЙ НАТУРАЛЬНОСТИ ПРОСТРАНСТВ

atlas concorde

## SOPHISTICATED WALLS FOR CONTEMPORARY AND NATURAL LOOK

PARETI SOFISTICATE PER UNA NATURALEZZA CONTEMPORANEA

**E**legant white-body wall tiles with the smooth velvety touch typical of brushed stone. The range includes the natural hues of stone coordinated with wall tiles in porcelain stoneware. A modern and contemporary combination of the substance and natural colours of stone with the shiny gleam of the marble-look tiles.

**E**leganti rivestimenti in pasta bianca presentano una superficie liscia dalla mano morbida tipica delle pietre spazzolate. La gamma include toni naturali effetto pietra coordinati con i pavimenti in gres porcellanato. Attuale e contemporaneo l'abbinamento materico e cromatico alle brillanti superfici effetto marmo.

01

CLAU  
ZETTO  
WHITE

02

DES  
ERT  
BEIGE

03

CARD  
OSO  
ELEGANT

50X110  
19<sup>5</sup>/<sub>8</sub>"x43<sup>1</sup>/<sub>4</sub>"

40X80  
15<sup>3</sup>/<sub>4</sub>"x31<sup>1</sup>/<sub>2</sub>"

atlas concorde

Des revêtements élégants en pâte blanche présentent une surface plate, souple au toucher, comme c'est le cas pour les pierres brossées. La gamme inclut des tonalités naturelles effet pierre assorties avec des sols en grès cérame. L'association des matériaux et des couleurs avec les surfaces brillantes effet marbre est moderne et contemporaine. Elegante Wandbeläge aus weißscherbiger Keramik mit glatter Oberfläche und weicher Haptik, die typisch für gebürstete Natursteine ist. Die natürlichen Nuancen der Natursteinoptik sind perfekt auf die Bodenbeläge aus Feinsteinzeug abgestimmt. Aktuell und zeitgemäß die stoffliche und farbliche Kombination zu den glänzenden Oberflächen in Marmoroptik. Elegantes revestimientos de pasta blanca presentan una superficie lisa y suave al tacto típica de las piedras cepilladas. La serie incluye tonos naturales efecto piedra coordinados con pavimentos de gres porcelánico. Actual y contemporánea la combinación de materia y cromatismo con las brillantes superficies efecto mármol. Уэлегантной настенной плитки из белой глины мягкая на ощупь поверхность, характерная для шлифованных камней. Палитра включает натуральные каменные тона, которые сочетаются с напольным керамогранитом. Восхитительно актуально выглядит сочетание с глянцевыми поверхностями под мрамор.

atlas concorde

## PLOT

Clauzetto White | Desert Beige

50X110

19<sup>5</sup>/<sub>8</sub>"x43<sup>1</sup>/<sub>4</sub>"

Les revêtements tridimensionnels effet pierre créent des scénographies décoratives qui sillonnent les parois de manière naturelle. La surface mate et brillante est riche en détails design en relief qui donnent une esthétique sophistiquée et recherchée, qui va associer les aspects décoratifs des pierres sculptées aux avantages de la meilleure céramique de revêtement. Dreidimensionale Wandbeläge in Natursteinoptik schaffen mit Natürlichkeit eine dekorative Wandinszenierung. Die helle, matte Oberfläche mit Designreliefs, die eine gepflegte Optik entstehen lassen, verbindet den dekorativen Charakter gehauener Natursteine mit den Vorzügen bester Wandkeramik. Revestimientos tridimensionales efecto piedra crean escenográficas decoraciones que surcan con naturaleza la pared. La superficie opaca y luminosa está rica de relieves que confieren una estética culta y elegante, uniendo el aspecto ornamental de las piedras esculpidas con las ventajas de la mejor cerámica de revestimiento. Трехмерная плитка придает стенам роскошную и в то же время натуральную декоративность. Матовая, богатая рельефами поверхность объединяет орнаментальность резных камней с преимуществами лучшей настенной керамики.

**T**hree-dimensional stone-effect wall tiles create scenic decorations for superbly naturally engraved walls.

Matt and gloss surfaces feature designer relief elements that confer a refined aesthetic sense, where the ornamental aspect of sculptured stone blends with the practicality of premium quality wall tile ceramics.

*R*ivestimenti tridimensionali effetto pietra creano decorative scenografie che solcano con naturalezza la parete. La superficie opaca e luminosa è ricca di rilievi di design che conferiscono un'estetica colta e ricercata, unendo l'aspetto ornamentale delle pietre scolpite ai vantaggi della migliore ceramica da rivestimento.

RELIEF FEATURES  
FOR WALLS OF  
RARE ELEGANCERILIEVI PER PARETI  
DI RARA ELEGANZA

**RELIEFS POUR PAROIS D'UNE RARE ÉLÉGANCE**  
**RELIEFS FÜR WÄNDE VON RARER ELEGANZ**  
**RELIEVES PARA PAREDES DE UNICA ELEGANCIA**  
**РЕЛЬЕФ ДЛЯ СТЕН РЕДКОЙ ЭЛЕГАНТНОСТИ**

## MESH

Clauzetto White | Desert Beige

40X80

15<sup>3</sup>/<sub>4</sub>"x31<sup>1</sup>/<sub>2</sub>"

atlas concorde

# M+S = IMPRESSIVE ARCHITECTURAL SCENERY

SCENARI ARCHITETTONICI D'IMPATTO

**T**he combination of exciting elegant marble and stone-look surfaces inspires new sceneries of contemporary luxury. Interior and exterior spaces in commercial and home settings featuring a natural elegance and sophisticated personality. Unusual blends of differently inspired materials create environments of outstanding contemporary refinement.

**A**bbinando elegantissime superfici aspetto marmo e pietra prendono vita i nuovi scenari del lusso contemporaneo: spazi interni e ambienti esterni in ambito commerciale e abitativo si distinguono per eleganza naturale e personalità sofisticata. Inedite combinazioni di materiali di diversa ispirazione realizzano contesti dalla raffinatezza estrema e attuale.

En associant des surfaces très élégantes en marbre et en pierre, on arrive à créer les nouveaux scénarios du luxe contemporain: des espaces intérieurs et des décors extérieurs plus commerciaux et d'habitation se démarquent par leur élégance naturelle et leur personnalité sophistiquée. Des associations inédites de matériaux différents permettent de réaliser des contextes au raffinement extrême et moderne. Durch die Kombination eleganter Oberflächen in Marmor- und Natursteinoptik entstehen neue Raumwelten in modernem Luxusdesign: Innenräume und Außenräume in Objekt- und Wohnbereichen zeichnen sich durch natürliche Eleganz und charakterstarke Ästhetik aus. Ungewöhnliche Kombinationen aus Materialien unterschiedlicher Inspiration lassen extrem raffinierte und aktuelle Gestaltungen entstehen. Combinando elegantísimas superficies aspecto mármol y piedra adquieren vida los nuevos escenarios del lujo contemporáneo: espacios interiores y ambientes exteriores en zonas comerciales y de vivienda se distinguen por la elegancia natural y personalidad sofisticada. Inéditas combinaciones de materiales de diferente inspiración realizan contextos de exquisitez extrema y actual. Сочетание фактур мрамора и камня создает роскошную современную обстановку. Внутренние и наружные пространства в домашних и коммерческих контекстах излучают натуральную элегантность. Оригинальное соседство разных материалов заливает пространства стильной актуальной изысканностью.

SCENARIOS ARCHITECTURAUX D'IMPACT  
EINDRUCKSVOLLE RAUMWELTEN  
ESCENARIOS ARQUITETÓNICOS DE IMPACTO  
ЭФФЕКТНЫЕ АРХИТЕКТУРНЫЕ ПРОСТРАНСТВА

atlas concorde

atlas concorde

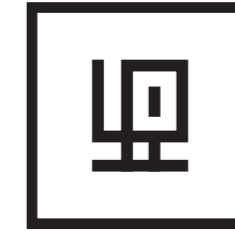

# NATURAL AND ESSENTIAL ATMOSPHERE

ATMOSFERA NATURALE ED ESSENZIALE

Surfaces inspired by luxuriously sophisticated marble and the simple natural elegance of stone design interior spaces that stand out for their style and personality. The substantial feel of stone acquires a touch of class when placed next to walls and slithers of colour inspired by precious, cutting-edge marble.

*Un progetto d'arredo unisce pavimenti e rivestimenti ispirati a marmi dal lusso sofisticato a superfici effetto pietra dall'eleganza minimale, dando vita a progetti di interior design che si distinguono per stile e personalità. L'aspetto materico della pietra acquista un tocco di classe combinandosi con pareti e squarci cromatici ispirati a marmi pregiati e di tendenza.*

PROJECT  
CONTEMPORARY LIVING AND HOME OFFICE

LOCATION  
LONDON

MARVELSTONE ITEMS  
CARRARA PURE, BARDIGLIO GREY, BASALTINA VOLCANO

M+S



**ATMOSPHERE SOBRE ET NATURELLE**  
*SCHLICHT-NATÜRLICHE ATMOSPHERE*  
**ATMÓSFERA NATURAL Y ESENCIAL**  
*НАТУРАЛЬНАЯ И ЛАКОНИЧНАЯ АТМОСФЕРА*

Un projet de décoration qui allie des sols et des murs inspirés de marbres au luxe sophistiqué, à des surfaces effet pierre à la sobre élégance, en donnant ainsi naissance à des projets de décoration d'intérieur qui se distinguent de par leur classe et leur caractère. L'aspect de la pierre acquiert une touche de classe en se combinant aux murs et aux éclats chromatiques qui s'inspirent de marbres de qualité et de tendance. Ein Einrichtungsprojekt aus Boden- und Wandbelägen, die an edlem, luxuriösem Marmor und Naturstein inspiriert sind. Minimalistische Eleganz für Interior Design-Projekte, die mit Stil und Persönlichkeit bestechen. Der stoffliche Aspekt des Steins erhält besondere Klasse durch die Verbindung mit Wänden und Farbakzenten, die an hochwertigen und aktuellen Marmorarten inspiriert sind. Proyecto de decoración que une pavimentos y revestimientos inspirados en mármoles de lujo sofisticado con superficies de efecto piedra de elegancia minimalista, dando vida a proyectos de diseño de interiores que se distinguen por su estilo y personalidad. El aspecto de la materia de la piedra adquiere un toque de clase combinándose con paredes y aperturas cromáticas inspiradas en mármoles de gran prestigio y moda. Роскошный оформительский проект сочетает напольную и настенную плитку, имитирующую пленительную изысканность мрамора и строгую элегантность камня, для придания пространствам стильного благородства. Вещественный вид камня приобретает ноту утонченности благодаря соседству с элитной фактурой мрамора на стенах.

**High-gloss porcelain tiles with a mirror-like brilliance capture the essence of white Carrara marble.**  
*Superfici in gres porcellanato effetto marmo Carrara dalle luminose e brillanti specchiature.*

Surfaces en grès cérame effet marbre Carrara aux surfaces lumineuses et miroitantes. Oberflächen aus Feinsteinzeug mit Carrara-Marmoroptik, leuchtende und glänzende Spiegeleffekte. Superficies de gres porcelánico de efecto mármol de Carrara de luminosos y brillantes reflejos. Керамогранит с блестящей и светлой фактурой каррарского мрамора.

PORCELAIN TILES  
 Marvel Carrara Pure Lappato 75x150  
 Marvel Bardiglio Grey Lappato 75x150  
 Marvel Basaltina Volcano 75x150  
 Marvel Carrara Pure Chevron Lappato 22,5x22,9

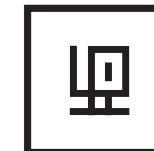



atlas concorde

**Tonalities inspired by lava stone that combine minimalistic style and chromatic vigour.**

*Tonalità ispirata alla pietra di lava che unisce stile minimal e vigore cromatico.*

Grès cérame imitant la pierre de lave qui, au style minimaliste, allie une tonalité de noir particulièrement intense. Am Lavastein inspirierter Farbton, der minimalistischen Stil mit Farbkraft vereint. Tonalidad inspirada en la piedra de lava que une su estilo minimalista con su vigor cromático. Цвет вулканического камня, соединивший минимализм и силу.



atlas concorde

PORCELAIN TILES

Marvel Carrara Pure Lappato 75x150

Marvel Bardiglio Grey Lappato 75x150

Marvel Basaltina Volcano 75x150

Marvel Carrara Pure Chevron Lappato 22,5x22,9



PORCELAIN TILES

Marvel Carrara Pure Lappato 75x150

Marvel Bardiglio Grey Lappato 75x150

Marvel Basaltina Volcano 75x150

Marvel Carrara Pure Chevron Lappato 22,5x22,9



PORCELAIN TILES  
 Marvel Carrara Pure Lappato 75x150  
 Marvel Bardiglio Grey Lappato 75x150  
 Marvel Basaltina Volcano 75x150  
 Marvel Carrara Pure Chevron Lappato 22,5x22,9

**Resistant to acids and detergents.**  
*Resiste agli acidi e ai detersivi.*  
 Résiste aux acides et aux détergents.  
 Beständig gegen Säuren und  
 Reinigungsmittel. Resiste a los ácidos y a los  
 detergentes. Стоек к кислотам и моющим  
 средствам.

PORCELAIN TILES  
 Marvel Carrara Pure Lappato 75x150  
 Marvel Bardiglio Grey Lappato 75x150  
 Marvel Basaltina Volcano 75x150  
 Marvel Carrara Pure Chevron Lappato 22,5x22,9



MARBLE LOOK

## CHEVRON LAPPATO

22,5x22,9 cm - 8<sup>3</sup>/<sub>4</sub>"x9"

Available in: Carrara Pure, Bianco Dolomite, Bardiglio Grey, Cream Prestige, Nero Marquina

PORCELAINTILESDECOR



Marvel Carrara Pure Chevron Lappato 22,5x22,9 cm

MARBLE LOOK

## MOSAICO LAPPATO BURATTATO

29,8x29,8 cm - 11<sup>3</sup>/<sub>4</sub>"x11<sup>3</sup>/<sub>4</sub>"

Available in: Carrara Pure, Bianco Dolomite, Bardiglio Grey, Cream Prestige, Nero Marquina

PORCELAINTILESDECOR



Marvel Bardiglio Grey Mosaico Lappato Burattato 29,8x29,8



## REFINED AND PRESTIGIOUS STYLE

CLASSE SOFISTICATA E PRESTIGIOSA

Large-sized marble-look porcelain tiles for floors and walls capture the white of marble with its refined minimalist style. The exclusive splendour of shiny wall tiles and luminous floors inspired by marble is joined by the natural feel of stone-effect surfaces in soft sand and oatmeal.

*Pavimenti in gres porcellanato effetto marmo e rivestimenti nell'ampio formato riproducono un marmo bianco dal tono caldo avoriato, dall'aspetto raffinato e minimale. Allo splendore unico di rivestimenti lucidi e pavimenti luminosi ispirati al marmo si aggiunge il tocco naturale di superfici effetto pietra, in un beige caldo e avvolgente.*

PROJECT  
RELAXING BATHROOM

LOCATION  
DUBAI

MARVELSTONE ITEMS  
BIANCO DOLOMITE, DESERT BEIGE

M+S



WALL TILES  
Marvel Bianco Dolomite 50x110  
TRIM TILES  
Marvel Bianco Dolomite Spigolo 0,8x20  
PORCELAIN TILES  
Marvel Desert Beige 45x90

**CHIC PRESTIGIEUX ET SOPHISTIQUE**  
*EDLE UND STILVOLLE ELEGANZ*  
**ESTILO SOFISTICADO Y PRESTIGIOSO**  
*ЭЛИТНОЕ И ИЗЫСКАННОЕ БЛАГОРОДСТВО*

Les sols en grès cérame effet marbre et les revêtements muraux grand format reproduisent un marbre blanc d'une chaude tonalité ivoire, à l'aspect raffiné et minimaliste. La splendeur unique de revêtements muraux brillants et de sols lumineux effet marbre est valorisée par la touche naturelle de surfaces effet pierre, d'un beige chaud et enveloppant. Bodenbeläge aus Feinsteinzeug mit Marmoroptik und großformatige Wandfliesen reproduzieren einen weißen Marmor in warmem Elfenbein. Edel und minimalistisch. Der unvergleichliche Glanz der am Marmor inspirierten, polierten Wandfliesen und strahlenden Böden wird durch die natürliche Note der Flächen mit Steinoptik in einem warmen und behaglichen Beige bereichert. Pavimentos de gres porcelánico de efecto mármol y revestimientos de gran tamaño reproducen mármoles blancos de tono cálido marfilado, de aspecto refinado y minimalista. Al resplandor único de revestimientos brillantes y pavimentos luminosos inspirados en el mármol se añade el toque natural de superficies de efecto piedra, en un beige cálido y que envuelve. Напольный керамогранит под мрамор и крупноформатная настенная плитка воспроизводят минималистический рисунок белого мрамора с оттенком цвета слоновой кости. Сияющая роскошь глянцевых «мраморных» стен и полов дополнена натуральным штрихом каменной фактуры бежевого тона.

**Surfaces in the warm natural colours of sand and oatmeal, with hints of grey and light veins.**  
*Superfici dalla tonalità beige, calda e naturale, caratterizzata da una punta di grigio e da venature chiare.*

Surfaces d'une tonalité beige chaude et naturelle, caractérisée par des veinures claires et une pointe de gris. Oberflächen in einem warmen und natürlichen Beigeton mit einer Grau-Note und hellen Aderungen. Superficies de tonalidad beige, cálida y natural, caracterizada por un toque de gris y por vetas claras. На теплых бежевых поверхностях изящно выделяются легкие оттенки серого цвета и светлые прожилки.

WALL TILES  
Marvel Bianco Dolomite 50x110  
Marvel Desert Beige 50x110  
Marvel Desert Beige Tumbled Mosaic 30x30  
TRIM TILES  
Marvel Bianco Dolomite Spigolo 0,8x20  
PORCELAIN TILES  
Marvel Bianco Dolomite Lappato 75x150  
Marvel Desert Beige 45x90  
Marvel Desert Beige Mosaico Burattato 29,8x29,8





atlas concorde

**Elegant varieties of Italian off-white marble, broken by delicate tone-on-tone shades and subtle veins.**

*Elegante varietà di marmo italiano dal bianco avorio interrotto da leggere sfumature tono su tono e da sottili venature.*

*Élégante variété de marbre italien d'un blanc ivoire agrémenté de légères nuances ton sur ton et de fines veinures. Elegante italienische Marmororte in Elfenbeinweiß, skandiert durch leichte Ton in Ton-Nuancen und feine Aderungen. Elegante variedad de mármol italiano blanco marfil atravesado por suaves matices tono sobre tono y por finas vetas. Элегантный итальянский мрамор цвета слоновой кости с мягкими переходами тон в тон и тонкими прожилками.*



PORCELAIN TILES  
Marvel Bianco Dolomite Lappato 75x150



atlas concorde

WALL TILES  
Marvel Bianco Dolomite 50x110  
TRIM TILES  
Marvel Bianco Dolomite Spigolo 0,8x20  
PORCELAIN TILES  
Marvel Bianco Dolomite Lappato 75x150  
Marvel Desert Beige 45x90



atlas concorde



atlas concorde

WALL TILES  
 Marvel Bianco Dolomite 50x110  
 Marvel Desert Beige Tumbled Mosaic 30x30  
 TRIM TILES  
 Marvel Bianco Dolomite Spigolo 0,8x20  
 PORCELAIN TILES  
 Marvel Bianco Dolomite Lappato 75x150  
 Marvel Desert Beige 45x90  
 Marvel Desert Beige Mosaico Burattato 29,8x29,8

**Shade and brilliance remain  
 inalterable over time.**  
*Tonalità e brillantezza sono inalterabili  
 nel tempo.*

La teinte et le brillant sont inaltérables dans le  
 temps. Farbton und Glanz verändern sich nicht  
 im Laufe der Zeit. Tonalidad y brillo inalterables  
 a lo largo del tiempo. Сохраняет цвет и блеск  
 даже после долгих лет эксплуатации.

WALL TILES  
 Marvel Desert Beige 50x110  
 Marvel Desert Beige Tumbled Mosaic 30x30  
 PORCELAIN TILES  
 Marvel Desert Beige Mosaico Burattato 29,8x29,8

STONE LOOK

## MOSAICO BURATTATO

29,8x29,8 cm - 1<sup>1</sup>/<sub>4</sub>"x1<sup>1</sup>/<sub>4</sub>"

Available in: Clauzetto White, Desert Beige, Cardoso Elegant, Basaltina Volcano

PORCELAIN TILES DECOR



Marvel Desert Beige Mosaico Burattato 29,8x29,8



Marvel Desert Beige Tumbled Mosaic 30x30

STONE LOOK

## TUMBLED MOSAIC

30x30 cm - 1<sup>1</sup>/<sub>4</sub>"x1<sup>1</sup>/<sub>4</sub>"

Available in: Clauzetto White, Desert Beige, Cardoso Elegant

WALL TILES DECOR



# SOPHISTICATED DESIGNER PROJECT

PROGETTO DAL DESIGN COLTO

Walls and floors inspired by the warmth and naturalness of sand-coloured stone to create environments in a minimalist and refined style, lit by the strong contrast with marble-effect elements. Three-dimensional ceramic tiles create accent walls that capture the effect of sculptured stone.

*Rivestimenti e pavimenti ispirati al calore e alla naturalezza della pietra beige creano ambienti dallo stile minimal ed elegante, acceso dal contrasto deciso con elementi effetto marmo. Rivestimenti ceramici tridimensionali danno vita a quinte scenografiche che richiamano l'effetto delle pietre scolpite.*



PROJECT  
RESIDENTIAL DESIGNER BATHROOM

LOCATION  
MÜNICH

MARVELSTONE ITEMS  
DESERT BEIGE, NERO MARQUINA



atlas concorde



WALL TILES  
Marvel Desert Beige 40x80

atlas concorde

**PROJET AU DESIGN SAVAMMENT ORCHESTRÉ**

*EIN PROJEKT VON EDLEM DESIGN*

**PROYECTO DE DISEÑO SOFISTICADO**

*ИСКУСНЫЙ ДИЗАЙН*

Les sols et les revêtements muraux s'inspirant de la chaleur et de la pierre beige naturelle créent des espaces au style élégant et minimaliste, illuminés par le fort contraste apporté par les éléments effet marbre. Les revêtements céramiques tridimensionnels créent des décors scénographiques qui rappellent l'effet de la pierre gravée. An der Wärme und Natürlichkeit des beigefarbenen Steins inspirierte Wand- und Bodenfliesen erzeugen ein Ambiente in elegant-minimalistischem Stil, der durch den markanten Kontrast mit Elementen in Marmoroptik belebt wird. Dreidimensionale Wandbeläge erzeugen szenografische Kulissen, die an behauene Steine erinnern. Revestimientos y pavimentos inspirados en el calor y en la naturaleza de la piedra beige, crean entornos de estilo minimalista y elegante, revivido por el contraste fuerte con elementos de efecto mármol. Revestimientos cerámicos tridimensionales crean palcos escenográficos que evocan el efecto de las piedras esculpidas. Элегантный минималистический стиль, созданный в интерьере настенной и напольной плиткой бежевого цвета под камень, оживлен контрастом с элементами под мрамор. Трехмерная плитка на стенах подобна резным камням.

**The warmth and naturalness of stone with a touch of grey, traced with typical light veins.**  
*Look pietra dalla nuance calda e naturale con una punta di grigio, solcata da tipiche venature chiare.*

Aspect pierre aux nuances chaudes et naturelles, agrémenté d'une pointe de gris et sillonné des typiques veinures claires. Steinoptik in einem warmen und natürlichen Farbton mit einer Grau-Note und von charakteristischen, hellen Aderungen durchzogen. Aspecto piedra de matiz cálido y natural con un toque de gris, surcado por típicas vetas claras. Теплая фактура камня с мягким вкраплением серого оттенка изображена светлыми прожилками.

- WALL TILES
- Marvel Desert Beige 40x80
- 3D WALL TILES
- Marvel 3D Mesh Desert Beige 40x80
- TRIM TILES
- Marvel Desert Beige Spigolo 10 mm 1x20
- PORCELAIN TILES
- Marvel Desert Beige 75x150
- Marvel Nero Marquina Lappato 75x150



atlas concorde



## STONE LOOK

## 3D MESH

40x80 cm - 15<sup>3</sup>/<sub>4</sub>"x31<sup>1</sup>/<sub>2</sub>"

**Available in:** Clauzetto White, Desert Beige

Unusual three-dimensional effects emerge from the ceramic surfaces, which change according to the light.

*Sulla superficie ceramica effetto pietra affiorano inediti effetti tridimensionali, che mutano in base all'incidenza della luce.*

Des effets tridimensionnels inédits émergent sur la surface céramique effet pierre et varient en fonction de l'incidence de la lumière. Auf der keramischen Oberfläche mit Steinoptik entstehen neue dreidimensionale Effekte, die je nach Lichteinfall variieren.

En la superficie cerámica de efecto piedra brotan inéditos efectos tridimensionales, que cambian según la incidencia de la luz. На керамической поверхности под камень стильно выступают трехмерные мотивы, которые меняются в зависимости от падения света.

## 3D WALLTILES



Marvel 3D Mesh Desert Beige 40x80

- WALL TILES
- Marvel Nero Marquina 50x110
- Marvel Nero Marquina Mosaic Q 30,5x30,5
- 3D WALL TILES
- Marvel 3D Mesh Desert Beige 40x80
- TRIM TILES
- Marvel Nero Marquina Spigolo 0,8x20
- PORCELAIN TILES
- Marvel Desert Beige 75x150
- Marvel Nero Marquina Lappato 75x150

### Easy cleaning and maintenance, just like a standard ceramic floor.

*Facile manutenzione e pulizia, come per un comune pavimento in ceramica.*

Entretien et nettoyage facile, comme pour un sol en céramique commun. Einfache Reinigung und Pflege, wie bei einem gewöhnlichen Keramikboden. Fácil mantención y limpieza, como para un común pavimento de cerámica. Простота чистки и ухода, как и для обычного плиточного пола.



**MARBLE LOOK**

**MOSAIC Q**

30,5x30,5 cm - 12"x12"

*Available in: Carrara Pure, Bianco Dolomite, Bardiglio Grey, Cream Prestige, Nero Marquina*

WALLTILESDECOR



WALL TILES  
Marvel Nero Marquina 50x110

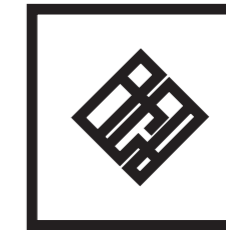

# PROFOUND AND PERSUASIVE IMPACT

IMPATTO PROFONDO E VIGOROSO

The strong, distinctive marble-look porcelain tile Bardiglio in an exclusive grey meets the pure white of Carrara marble-look surfaces, with their delicate swirls and veins. The luxury of honed marble-effect tiles is offset by the tactile elegance of stone-look, matte-finished surfaces, for showrooms, reception and hospitality areas in a modern design.

*Un gres porcellanato effetto marmo Bardiglio dal ricercato fondo grigio e dal carattere deciso incontra le superfici bianchissime ricche di lievi venature del marmo Carrara. Al lusso dell'effetto marmo lappato fa da contrappunto l'eleganza materica di superfici dal look pietra in finitura matt, per showroom, reception e spazi dell'accoglienza dallo stile contemporaneo.*

PROJECT  
CONTEMPORARY SHOWROOM

LOCATION  
NEW YORK

MARVELSTONE ITEMS  
BARDIGLIO GREY, CARRARA PURE, BASALTINA VOLCANO

M+S



atlas concorde

PORCELAIN TILES  
Marvel Bardiglio Grey Lappato 75x150

**IMPACT PROFOND ET VIGOREUX**  
**STARKER UND NACHHALTIGER EFFEKT**  
**IMPACTO PROFUNDO Y VIGOROSO**  
**ЭФФЕКТНЫЙ И КРЕПКИЙ ВИД**

Un grès cérame effet marbre Bardiglio au fond gris raffiné et de grand caractère, épouse des surfaces ultra blanches enrichies de fines veinures de marbre Carrara. Le luxe de l'effet marbre poli épouse l'élégance de la texture des surfaces aspect pierre finition mate, pour des showrooms et des espaces d'accueil au style contemporain. Ein Feinsteinzeug mit Marmoroptik Bardiglio. Edler, grauer Grund von starkem Charakter, kombiniert mit den schneeweißen, an leichten Äderungen reichen Flächen des Carrara-Marmors. Einen Gegensatz zum Luxus des polierten Marmors bildet die stoffliche Eleganz matter Steinoptik-Flächen für zeitgemäße Showrooms, Rezeptionen und Gemeinschaftsbereiche. Gres porcelánico de efecto mármol Bardiglio de elegante fondo gris y de carácter definido se conjuga con superficies blanquísimas ricas de tenues vetas del mármol de Carrara. Al lujo de efecto mármol lapeado sirve de contrapunto la elegancia de la materia de superficies de aspecto piedra de acabado matt, para showroom, recepción y espacios dedicados a la hospitalidad de estilo contemporáneo. Керамогранит под мрамор Bardiglio с изысканным серым фоном изящно сочетается с белизной каррарского мрамора, отмеченного мягкими прожилками. Столь же эффектно и актуально выглядит в шоу-румах, приемных зонах, холлах соседство лапатированных «мраморных» поверхностей с матовым каменным рисунком.

**Exclusive shades of grey with white veins and shading in dark and light grey.**  
*Ricercata varietà di grigio caratterizzata da venature bianche e da sfumature in grigio chiaro e scuro.*

Variété de gris raffiné, caractérisée par des veinures blanches et des tonalités gris clair et gris foncé.  
Erliesener Grauton mit weißen Äderungen und Nuancen in Hell- und Dunkelgrau. Refinada variedad de grises caracterizada por vetas blancas y por matices de gris claro y oscuro. Изысканный серый тон, перетекающий от светлых оттенков к темным, украшен белым прожилковым рисунком.

PORCELAIN TILES  
Marvel Carrara Pure Lappato 75x150  
Marvel Bardiglio Grey Lappato 75x150  
Marvel Basaltina Volcano 75x150  
Marvel Carrara Pure Mosaico Esagono 30 28,2x35,3



atlas concorde



atlas concorde

**Suitable for floor and wall application.**

*Applicabile a pavimento e a rivestimento.*

Applicable au sol et en revêtement. Einsetzbar als Fußboden und als Wandbelag. Aplicable como pavimento y como revestimiento. Подходит для укладки на полы и стены.



atlas concorde



PORCELAIN TILES  
 Marvel Carrara Pure Lappato 75x150  
 Marvel Bardiglio Grey Lappato 75x150  
 Marvel Basaltina Volcano 75x150  
 Marvel Carrara Pure Mosaico Esagono 3D 28,2x35,3

PORCELAIN TILES

Marvel Bardiglio Grey Lappato 75x150  
 Marvel Carrara Pure Lappato 75x150  
 Marvel Basaltina Volcano 75x150  
 Marvel Carrara Pure Mosaico Esagono 3D 28,2x35,3



**Carrara marble-effect porcelain tiles in pure white criss-crossed by light grey veins.**

*Gres porcellanato effetto marmo Carrara dal fondo bianchissimo attraversato da venature grigio chiaro.*

Grès cérame effet marbre Carrara au fond ultra blanc sillonné de veines gris clair. Feinsteinzeug in Carrara-Marmoroptik mit schneeweißem Grund, der von hellgrauen Äderungen durchzogen ist. Gres porcelánico de efecto mármol de Carrara de fondo blanquísimo atravesado por vetas gris claro.

У керамогранита с фактурой каррарского мрамора белый фон со светло-серыми прожилками.

**MARBLE LOOK**

## MOSAICO ESAGONO 3D

28,2x35,3 cm - 11"x14"

**Available in:** Carrara Pure, Bianco Dolomite, Bardiglio Grey, Cream Prestige, Nero Marquina

PORCELAIN TILES DECOR



Marvel Carrara Pure Mosaico Esagono 3D 28,2x35,3



PORCELAIN TILES  
 Marvel Carrara Pure Lappato 75x150  
 Marvel Bardiglio Grey Lappato 75x150  
 Marvel Basaltina Volcano 75x150  
 Marvel Carrara Pure Mosaico Esagono 3D 28,2x35,3

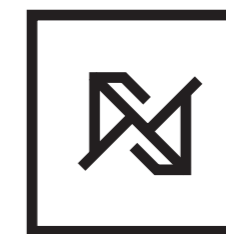

## STRONG, MODERN CHARACTER

DECISA PERSONALITÀ CONTEMPORANEA

Brilliant, luminous white-body wall tiles reproduce the depth and character of exclusive grey marble. With their distinctive beauty, the Bardiglio marble-effect wall tiles and coordinated porcelain floor tiles meet Cardoso stone-effect surfaces to create elegant chromatic designs.

*Brillanti e luminosi rivestimenti in pasta bianca riproducono la profondità di un ricercato marmo grigio della forte personalità. Caratterizzati da un'estetica distintiva, i rivestimenti effetto marmo Bardiglio e i pavimenti in gres porcellanato coordinati incontrano superfici effetto pietra Cardoso per eleganti composizioni cromatiche.*

PROJECT  
PRESTIGIOUS BATHROOM

LOCATION  
NEW YORK

MARVELSTONE ITEMS  
BARDIGLIO GREY, CARDOSO ELEGANT

M+S



WALL TILES  
Marvel Bardiglio Grey 50x110

atlas concorde

**CONTEMPORAIN ET DE GRAND CARACTÈRE**  
**ENTSCHLOSSENER, ZEITGENÖSSISCHER CHARAKTER**  
**FUERTE PERSONALIDAD CONTEMPORÁNEA**  
**ЯРКИЙ СОВРЕМЕННЫЙ ХАРАКТЕР**

Revêtements muraux en pâte blanche, brillants et lumineux, reproduisant la profondeur d'un marbre gris raffiné de grand caractère. Caractérisés par un esthétisme élégant et distinctif, les revêtements muraux effet marbre Bardiglio et les sols en grès cérame coordonnés, épousent des surfaces effet pierre Cardoso en créant des compositions chromatiques élégantes. Leuchtend und glänzende, weißschieferige Wandfliesen geben die Tiefe eines edlen grauen Marmors mit starker Persönlichkeit wieder. Die durch eine stilvolle Optik geprägten Wandbeläge mit Marmoroptik Bardiglio sowie die dazu passenden Feinsteinzeugböden treffen auf Flächen mit Steinoptik Cardoso und bilden elegante Farbkompositionen. Brillantes y luminosos revestimientos de pasta blanca reproducen la profundidad de un refinado mármol gris de fuerte personalidad. Caracterizados por su estética particular, los revestimientos de efecto mármol Bardiglio y los pavimentos de gres porcelánico coordinados, se conjugan con superficies de efecto piedra Cardoso para elegantes composiciones cromáticas. Сияющая настенная плитка из белой глины искусно воспроизводит глубину серого, ярко по характеру мрамора. Элегантные цветовые комбинации получаются из сочетания настенных плиток под мрамор Bardiglio, напольного керамогранита с той же фактурой и поверхностями под камень Cardoso.

**Easy to cut and drill, easier to install accessories and decorations.**  
*Facile da tagliare e forare, facilita l'installazione di accessori e arredi.*

Facile à couper et à percer, il facilite l'installation des accessoires et du mobilier. Leicht zu schneiden und zu bohren, einfache Verlegung von Zubehör und Einrichtungen. Fácil de cortar y perforar, facilita la instalación de accesorios y decoraciones. Легкость резки и сверления отверстий, простота монтажа аксессуаров и предметов обстановки.

WALL TILES  
Marvel Cardoso Elegant 50x110  
TRIM TILES  
Marvel Cardoso Elegant Spigolo 0.8x20  
PORCELAIN TILES  
Marvel Bardiglio Grey 75x150 Lappato



atlas concorde



WALL TILES  
 Marvel Bardiglio Grey 50x110  
 Marvel Cardoso Elegant 50x110  
 TRIM TILES  
 Marvel Bardiglio Grey Spigolo 0,8x20  
 PORCELAIN TILES  
 Marvel Bardiglio Grey 75x150 Lappato  
 Marvel Bardiglio Grey Listello Lappato 7x60

**No need for wax or polishing agents to maintain the shine of the surface.**  
*Non necessita di cera o lucidante per mantenere intatta la brillantezza della superficie.*

*Ne nécessite pas de cire ou de lustrants pour maintenir l'éclat de la surface. Keine Notwendigkeit für eine Behandlung der Oberfläche mit Wachs oder Politur, um deren Glanz beizubehalten. No necesita cera o abrillantador para mantener intacto el brillo de la superficie. Не требует обработки восковыми или полирующими средствами для сохранения блеска поверхности.*

WALL TILES  
 Marvel Bardiglio Grey 50x110  
 PORCELAIN TILES  
 Marvel Bardiglio Grey Listello Lappato 7x60





atlas concorde

**An exclusive play of tones of grey criss-crossed by deep white veins and dark and light shading.**  
*Una ricercata varietà di grigio solcata da profonde vene bianche e da sfumature chiare e scure.*

Une variété de gris raffiné sillonnée de profondes veines blanches et de tonalités claires et foncées. Ein erlesener Grauton mit tiefen, weißen Äderungen sowie hellen und dunklen Nuancen. Refinada variedad de gris surcado de profundas venas blancas y de matices claros y oscuros. Богатый серый тон, перетекающий от светлых оттенков к темным, изображен глубокими белыми прожилками.

**MARBLE LOOK**

## HERRINGBONE WALL

30,5x30 cm - 12"x11<sup>3</sup>/<sub>4</sub>"

**Available in:** Carrara Pure, Bianco Dolomite, Bardiglio Grey, Cream Prestige, Nero Marquina

WALLTILESDECOR



atlas concorde

Marvel Bardiglio Grey Herringbone Wall 30,5x30

- WALL TILES  
 Marvel Bardiglio Grey 50x110  
 Marvel Cardoso Elegant 50x110  
 Marvel Bardiglio Grey Herringbone Wall 30,5x30  
 TRIM TILES  
 Marvel Bardiglio Grey Spigolo 0,8x20  
 PORCELAIN TILES  
 Marvel Bardiglio Grey Listello Lappato 7x60  
 Marvel Cardoso Elegant 75x150





## PURE AND ELEGANT APPEAL

ELEGANZA PURA E LUMINOSA

Brilliant wall tiles inspired by white Carrara marble replicate the marble's natural beauty, with a light, luminous surface and rich scattering of delicate veins. Superb wall tiles are reflected on the coordinated honed porcelain tile floors, creating modern monochromatic designs, enlivened by the three-way colours of herringbone layout.

*Brillanti rivestimenti ispirati al marmo Carrara riproducono la bellezza della materia naturale, con una superficie chiara e luminosa ricca di delicate venature. Splendidi rivestimenti si specchiano su pavimenti coordinati in gres porcellanato lappato, dando vita a moderne composizioni monocromatiche, impreziosite dal decoro a spina di pesce in tre colori.*

PROJECT  
CHARMING HOME BATHROOM

LOCATION  
PARIS

MARVELSTONE ITEMS  
CARRARA PURE





atlas concorde

WALL TILES  
 Marvel Carrara Pure 50x110  
 Marvel Chevron Mix Wall 30,5x25  
 TRIM TILES  
 Marvel Carrara Pure Spigolo 0,8x20  
 PORCELAIN TILES  
 Marvel Carrara Pure Lappato 75x150

**ÉLÉGANCE PURE ET LUMINEUSE**  
**REINE UND ANSPRECHENDE ELEGANZ**  
**ELEGANCIA PURA Y LUMINOSA**  
**ЧИСТАЯ И СВЕТЛАЯ ЭЛЕГАНТНОСТЬ**

Les revêtements brillants qui s'inspirent du marbre Carrara reproduisent la beauté de la matière naturelle, avec une surface claire et lumineuse, enrichie de délicates veinures. De splendides revêtements se reflètent sur des sols coordonnés en grès cérame poli, en donnant naissance à de modernes compositions monochromatiques, enrichies par un décor en chevrons tricolores. Leuchtende Wandfliesen, am Carrara-Marmor inspiriert, bilden die Schönheit des natürlichen Materials mit heller, leuchtender Oberfläche voller zarter Äderungen nach. Herrliche Wandbeläge spiegeln sich auf den dazu passenden Bodenfliesen aus poliertem Feinsteinzeug wieder und erzeugen moderne, einfarbige Kompositionen, die durch das Fischgrätmuster in drei Farben bereichert werden. Brillantes revestimientos inspirados en el mármol de Carrara reproducen la belleza natural de la materia, cuya superficie clara y luminosa está rica de delicadas vetas. Espléndidos revestimientos se reflejan en pavimentos coordinados de grés porcelánico lapeado, dando vida a modernas composiciones monocromáticas, embellecidas por la decoración en forma de espina de pescado en tres colores. Яркая настенная плитка искусно воссоздает красоту натурального мрамора Carrara в своей светлой с богатым прожилковым рисунком поверхности. С настенной плиткой изящно гармонирует напольный лаппатированный керамогранит, рождая современные монохромные композиции, обогащенные оригинальным трехцветным декором в елочку.

**A pure white tile traced by subtle light greys veins.**  
*Un fondo bianco purissimo attraversato da sottili venature grigio chiare.*

Un fond blanc épuré sillonné de fines veinures gris clair. Blütenweißer Grund mit feinen, hellgrauen Äderungen. Fondo blanco purísimo atravesado por finas vetas grises claras. Белоснежный фон, пронизанный тонкими светло-серыми прожилками.

WALL TILES  
 Marvel Carrara Pure 50x110



atlas concorde



atlas concorde

**Brilliant high-gloss, white-body wall tiles are coordinated with honed porcelain floor tiles with a mirror-like surface.**

*Rivestimenti in pasta bianca lucidi e brillanti sono coordinati ai pavimenti in gres porcellanato lappato dalla superficie specchiante.*

Les revêtements muraux brillants en pâte blanche sont coordonnés aux sols en grés cérame poli à la surface miroitante. Weißscherbige, glänzende und leuchtende Wandbeläge sind auf die Bodenfliesen aus poliertem Feinsteinzeug mit spiegelblanker Oberfläche abgestimmt. Revestimientos de pasta blanca lucientes y brillantes están coordinados con los pavimentos de gres porcelánico lapeado de superficie reflectante. Сияющая настенная плитка из белой глины роскошно гармонирует с лапатированным напольным керамогранитом.



atlas concorde



WALL TILES  
Marvel Carrara Pure 50x110  
Marvel Chevron Mix Wall 30,5x25  
TRIM TILES  
Marvel Carrara Pure Spigolo 0,8x20  
PORCELAIN TILES  
Marvel Carrara Pure Lappato 75x150

WALL TILES  
Marvel Carrara Pure 50x110  
Marvel Chevron Mix Wall 30,5x25  
TRIM TILES  
Marvel Carrara Pure Spigolo 0,8x20  
PORCELAIN TILES  
Marvel Carrara Pure Lappato 75x150



## MARBLE LOOK

# CHEVRON MIX WALL

30,5x25 cm - 12"x9 7/8"

**Available in:** MIX (Carrara Pure + Bardiglio Grey + Nero Marquina)

COLD (Carrara Pure + Nero Marquina) WARM (Bianco Dolomite + Nero Marquina)

WALLTILESDECOR



**Low porosity of surface:  
high stain resistance.**  
*Bassa porosità della superficie:  
elevata resistenza alle macchie.*

*Faible porosité de la surface : résistance élevée  
aux taches. Niedrige Porosität der Oberfläche:  
hohe Fleckenbeständigkeit. Baja porosidad  
de la superficie: elevada resistencia a las  
manchas. Низкая пористость поверхности:  
высокая стойкость к образованию пятен.*



WALL TILES  
Marvel Carrara Pure 50x110  
Marvel Chevron Mix Wall 30,5x25  
PORCELAIN TILES  
Marvel Carrara Pure Lappato 75x150



Marvel Chevron Cold Lappato 22,5x22,9

**MARBLE LOOK**

PORCELAINTILESDECOR

## CHEVRON COLD LAPPATO

22,5x22,9 cm - 8<sup>3</sup>/<sub>4</sub>"x9"

Available in: COLD (Carrara Pure + Nero Marquina)



Marvel Half Hex Cold Lappato 33x48,3

**MARBLE LOOK**

PORCELAINTILESDECOR

## HALF HEX COLD LAPPATO

33x48,3 cm - 13"x19"

Available in: COLD (Carrara Pure + Nero Marquina)

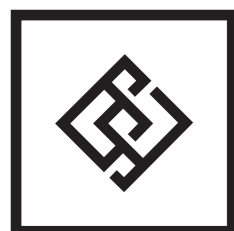

# SIMPLE AND STYLISH EXPERIENCE

ESPERIENZA DALLA CLASSE  
ESSENZIALE

The elegance of polished stone, with a wealth of details and slight imperfections, is captured in the highly tactile naturalness of porcelain tiles. The simplicity of stone, combined with marble-look details, gives rooms a stylish contemporary design.

*L'eleganza delle pietre spazzolate, ricche di dettagli e lievi irregolarità, rivive in un gres porcellanato dalla finitura materica e naturale. Il carattere essenziale della pietra, abbinato a dettagli dal look marmo, dona all'ambiente un raffinato stile contemporaneo.*

**M+S**

PROJECT  
RESTAURANT

LOCATION  
FRANKFURT AM MAIN

MARVELSTONE ITEMS  
CARDOSO ELEGANT, CLAUZETTO WHITE, NERO MARQUINA





atlas concorde

PORCELAIN TILES  
Marvel Cardoso Elegant 75x150  
Marvel Nero Marquina Lappato 75x150

**EXPÉRIENCE AU CHIC ESSENTIEL**  
*EINE SCHLICHTE UND STILVOLLE ERFAHRUNG*  
**EXPERIENCIA DE CLASE ESENCIAL**  
*ЛАКОНИЧНАЯ СТРОГОСТЬ*

L'élégance des pierres brossées, enrichies de détails et de légères irrégularités, est reproduite dans un grès cérame d'une finition texturée et naturelle. Le caractère essentiel de la pierre, associé à des détails aspect marbre, confère un style contemporain raffiné à l'espace. Die Eleganz des gebürsteten Steins mit seinen Details und leichten Unregelmäßigkeiten lebt in stofflich und natürlich verarbeitetem Feinsteinzeug wieder auf. Die Schlichtheit des Steins und die Details in Marmoroptik schenken dem Ambiente eine edle, zeitgenössische Wirkung. La elegancia de las piedras cepilladas, ricas de detalles y suaves irregularidades, renace en un gres porcelánico de acabado material y natural. El carácter esencial de la piedra, combinado con detalles de aspecto mármol, dona al ambiente un refinado estilo contemporáneo. Элегантность шлифованных камней, на которых видны богатые детали и легкие неровности, приобретает новое звучание в вещественной красоте керамогранита. Строгий вид камня в сочетании с «мраморными» вкраплениями придает интерьеру современную стильность.

**Stone-effect tiles in intense grey highlighted by elegant white veins for a modern look.**  
*Moderno effetto pietra di un grigio intenso attraversato da eleganti venature bianche.*

Effet pierre au gris intense et moderne, sillonné de veinures blanches très élégantes. Moderne Steinoptik in intensivem Grau mit eleganten, weißen Aderungen. Moderno efecto piedra de color gris intenso atravesado por elegantes vetas blancas. Современная фактура камня насыщенно-серого цвета, изображенного элегантными белыми прожилками.

PORCELAIN TILES  
Marvel Cardoso Elegant 75x150  
Marvel Clauzetto White 75x150  
Marvel Nero Marquina Lappato 75x150

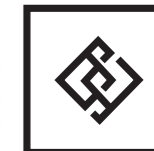

atlas concorde



atlas concorde

**Inspired by a fine-grained pearlized grey stone with subtle shading.**  
*Inspirata a una pietra grigio perla, dalla grana fine e con leggere sfumature.*

Inspirée d'une pierre gris perle au grain fin, agrémentée de légères nuances. Das Vorbild ist ein perlgrauer Stein mit feiner Körnung und leichten Nuancen. Inspirada en una piedra gris perla, de grano fino y de suaves matices. Жемчужно-серый цвет мелкозернистой текстуры с мягкими оттенками.



atlas concorde





PORCELAIN TILES  
 Marvel Cardoso Elegant 75x150  
 Marvel Clauzetto White 75x150  
 Marvel Nero Marquina Lappato 75x150  
 Marvel Terrazzo Grey Lappato 75x150

## MARVELGEMS

Surfaces inspired by Venetian Terrazzo create original contemporary spaces.

*Superfici ispirate al terrazzo veneziano creano originali spazi contemporanei.*

Des surfaces s'inspirant du granito pour créer des espaces contemporains originaux. Vom venezianischem Terrazzo inspirierte Oberflächen schaffen originelle, zeitgemäße Raumkonzepte. Superficies inspiradas en el terrazo crean espacios originales contemporáneos. Плитки с фактурой венецианского терраццо оригинально украшают современные пространства.

PORCELAIN TILES  
 Marvel Terrazzo Grey Lappato 75x150



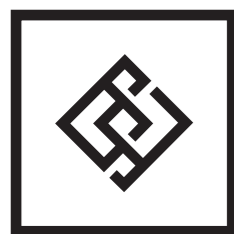

# WONDERFULLY NATURAL EXTERIOR

ECCELLENZA E NATURALITÀ IN ESTERNO

Textured porcelain tiles combine the elegance and beauty of stone with anti-slip and anti-frost properties, resistance to atmospheric damage and wear-and-tear. The 2 cm (3/4") thick porcelain tiles for floors combine high technical performance with easy of lay, for use in outside living areas, gardens, patios and swimming-pool areas.

*Il gres porcellanato strutturato unisce l'estetica elegante della pietra, a superfici antiscivolo resistenti a gelo, agenti atmosferici, usura e calpestio. Le pavimentazioni in gres porcellanato di 2 cm di spessore garantiscono ottime prestazioni tecniche e facilità di applicazione per dehors, giardini, patii e zone piscina.*

PROJECT  
OUTDOOR RESTAURANT

LOCATION  
FRANKFURT AM MAIN

MARVELSTONE ITEMS  
CLAUZETTO WHITE, CARDOSO ELEGANT

S





PORCELAIN TILES  
 Marvel Cardoso Elegant Strutturato 30x60  
 Marvel Clauzetto White 60x120 LASTRA 20 mm  
 Marvel Cardoso Elegant 75x150 Matt  
 Marvel Cardoso Elegant Brick 30x60  
 Marvel Clauzetto White 75x150  
 TRIM TILES  
 Marvel Cardoso Elegant Elemento L Strutturato 15x60 H.4

**EXCELLENCE ET NATUREL EN EXTÉRIEUR**  
*WUNDERBAR NATÜRLICHES FLAIR IM FREIEN*  
**EXCELENCIA Y NATURALEZA EN EXTERIORES**  
*КРАСОТА И НАТУРАЛЬНОСТЬ НА УЛИЦЕ*

Le grès cérame structuré allie l'esthétisme élégant de la pierre, à des surfaces antiglisse résistantes au gel, aux agents atmosphériques, à l'usure et au trafic. Les sols en grès cérame de 2 cm d'épaisseur garantissent d'excellentes performances techniques et une facilité de pose pour l'extérieur, les jardins, patios et alentours de piscine. Das strukturierte Feinsteinzeug vereint die elegante Optik des Steins mit einer rutschfesten Oberfläche und Beständigkeit gegen Frost, Witterungseinflüsse, Verschleiß und Trittbelastung. Der 2 cm starke Feinsteinzeughoden garantiert optimale technische Leistungen und einfache Verlegung in Außenbereichen, Gärten, Innenhöfen sowie um Swimming Pools. El grés porcelánico estructurado conjuga la estética elegante de la piedra con superficies antideslizantes, resistentes al hielo, a los agentes atmosféricos, al desgaste y al pisoteo. Los pavimentos de grés porcelánico de 2 cm de grosor garantizan óptimos rendimientos técnicos, además son fáciles de colocar en espacios al aire libre, jardines, patios y zonas piscina. Структурный керамогранит так же красив, как и природный камень, а вместе с тем нескользок и стоек к морозам, атмосферным воздействиям, износу, пешеходным нагрузкам. Поэтому керамогранитные плитки толщиной 2 см можно укладывать на террасах, в садах, патио, на участках вокруг бассейнов.

**Large 2 cm (3/4") thick porcelain slabs to design safe modern outdoor spaces.**  
*Lastre in gres porcellanato di spessore 2 cm per progettare in sicurezza gli spazi outdoor contemporanei.*

Dalles en grès cérame de 2 cm d'épaisseur pour concevoir des espaces extérieurs contemporains sous le signe de la sécurité. Feinsteinzeugplatten mit 2 cm Stärke zur Planung zeitgemäßer Outdoor-Bereiche. Placas de grés porcelánico de 2 cm de espesor para diseñar en total seguridad espacios contemporáneos al aire libre. Керамогранитные плитки толщиной 2 см для современного и безопасного оформления наружных пространств.

PORCELAIN TILES  
 Marvel Clauzetto White 60x120 LASTRA 20 mm





atlas concorde

PORCELAIN TILES  
 Marvel Cardoso Elegant Strutturato 30x60  
 Marvel Clauzetto White 60x120 LASTRA 20 mm  
 Marvel Cardoso Elegant 75x150 Matt  
 Marvel Cardoso Elegant Brick 30x60  
 Marvel Clauzetto White 75x150  
 TRIM TILES  
 Marvel Cardoso Elegant Elemento L Strutturato 15x60 H.4

**Textured stone-effect porcelain tiles with a brush-hammered surface for outdoor spaces and damp areas.**  
 Gres porcellanato strutturato effetto pietra con superficie micro bocciardata per esterni e zone umide.

Grès cérame structuré effet pierre à surface légèrement bouchardée pour extérieur et zones humides. Strukturiertes Feinsteinzeug mit Steinoptik und fein gekörnelter Oberfläche für Außen- und Feuchtbereiche. Gres porcelánico estructurado de efecto piedra con superficie micro abujardada para exteriores y zonas húmedas. Структурный керамогранит под камень с микробучардированной поверхностью для уличных и влажных пространств.

PORCELAIN TILES  
 Marvel Cardoso Elegant Strutturato 30x60  
 Marvel Clauzetto White 60x120 LASTRA 20 mm  
 Marvel Cardoso Elegant 75x150 Matt  
 Marvel Cardoso Elegant Brick 30x60  
 Marvel Clauzetto White 75x150  
 TRIM TILES  
 Marvel Cardoso Elegant Elemento L Strutturato 15x60 H.4

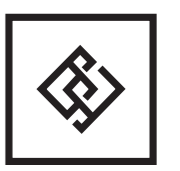

atlas concorde



PORCELAIN TILES  
Marvel Cardoso Elegant Strutturato 30x60  
Marvel Clauzetto White 60x120 LASTRA 20 mm  
Marvel Cardoso Elegant 75x150 Matt  
Marvel Cardoso Elegant Brick 30x60  
Marvel Clauzetto White 75x150  
TRIM TILES  
Marvel Cardoso Elemento L Strutturato 15x60 H.4



Marvel Cardoso Elegant Brick 30x60

**STONE LOOK**

**BRICK**

30X60 CM - 11<sup>3</sup>/<sub>4</sub>"x23<sup>5</sup>/<sub>8</sub>"

*Available in: Clauzetto White, Desert Beige, Cardoso Elegant, Basaltina Volcano*

PORCELAIN TILES DECOR

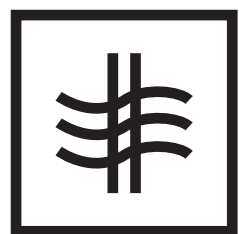

# ELEGANT AND MINIMALIST STYLE

STILE MINIMALE ED ELEGANTE

Sophisticated 50x110 cm (19<sup>5</sup>/<sub>8</sub>"x 43<sup>1</sup>/<sub>4</sub>" ) white body wall tiles create walls that capture the smooth, natural surface of brushed stone. Three-dimensional ceramic tiles imitate sculptured stone to create vibrant decorative settings in simple, yet stylish, wellness spaces.

*Raffinati rivestimenti in pasta bianca nel formato 50x110 cm creano pareti dalla superficie liscia e naturale come una pietra spazzolata. Superfici ceramiche tridimensionali imitano la pietra scolpita creando vibranti scenografie decorative in spazi benessere dallo stile essenziale.*

**M+S**

PROJECT  
RESTAURANT RESTROOM

LOCATION  
FRANKFURT AM MAIN

MARVELSTONE ITEMS  
CLAUZETTO WHITE, CARDOSO ELEGANT, NERO MARQUINA



atlas concorde

WALL TILES  
Marvel Cardoso Elegant 50x110  
PORCELAIN TILES  
Marvel Nero Marquina Lappato 75x150

**STYLE MINIMALISTE ET ÉLÉGAN**  
*MINIMALISTISCH-ELEGANTER STIL*  
**ESTILO MINIMALISTA Y ELEGANTE**  
*ЭЛЕГАНТНЫЙ МИНИМАЛИСТИЧЕСКИЙ СТИЛЬ*

Revêtements muraux très raffinés, en pâte blanche format 50x110 cm, pour créer des murs à surface lisse et naturelle comme une pierre brossée. Surfaces céramiques tridimensionnelles imitant la pierre gravée pour créer des scénographies décoratives de grand impact pour des espaces de bien-être au style essentiel. Edle, weißscherbige Wandbeläge im Format 50x110 cm bilden Wände mit glatter und natürlicher Oberfläche wie ein gebürsteter Stein. 3D-Keramikflächen empfinden den behauenen Stein nach und erzeugen schwingende, dekorative Szenografien in schlicht gehaltenen Wellness-Bereichen. Refinados revestimientos de pasta blanca de tamaño 50x110 cm crean paredes de superficie lisa y natural como una piedra cepillada. Superficies cerámicas tridimensionales imitan la piedra esculpida creando vibrantes escenografías decorativas en espacios dedicados al bienestar de estilo esencial. Грациозная плитка из белой глины 50x110 см придает стенам гладкий и натуральный вид, как у шлифованного камня. Трехмерные поверхности, подобные резному камню, становятся роскошным декором лаконичных по стилю велнес-пространств.

**Modern take on grey with white veins  
and a tasteful dynamic play of colours.**  
*Moderna cadenza di grigio dalle  
venature bianche e dal raffinato  
movimento cromatico.*

Cadence moderne de gris aux veinures blanches  
et au mouvement chromatique raffiné. Modern  
skandiertes Grau mit weißen Äderungen und  
einer edlen, farblichen Bewegung. Moderna  
armonía de grises de vetas blancas y de refinado  
movimiento cromático. Актуальный серый  
цвет с белыми прожилками и изысканными  
переходами оттенков.

WALL TILES  
Marvel Cardoso Elegant 50x110  
TRIM TILES  
Marvel Clauzetto White Spigolo 10mm 1x20  
PORCELAIN TILES  
Marvel Clauzetto White 75x150



atlas concorde



## STONE LOOK

# 3D PLOT

50x110 cm - 19<sup>5</sup>/<sub>8</sub>"x43<sup>1</sup>/<sub>4</sub>"

Available in: Clauzetto White, Desert Beige

Elegantly textured three-dimensional ceramic wall tiles create dynamic walls that look like sculptured stone.

Revêtements céramiques tridimensionnels d'une texture raffinée pour donner du dynamisme aux murs effet pierre gravée. 3D-Keramikverkleidungen mit edler Textur bilden dynamische Wände, die wie behauener Stein wirken.

*Rivestimenti ceramici tridimensionali dalla texture ricercata creano dinamiche pareti a effetto pietra scolpita.*

Revestimientos cerámicos tridimensionales de textura elegante crean paredes dinámicas de efecto piedra esculpida. Трехмерная плитка с изящной текстурой рождает на стенах эффект резного камня.

## 3D WALLTILES



Marvel 3D Plot Clauzetto White 50x110



WALL TILES  
Marvel Cardoso Elegant 50x110  
3D WALL TILES  
Marvel 3D Plot Clauzetto White 50x110  
TRIM TILES  
Marvel Clauzetto White Spigolo 10 mm 1x20  
PORCELAIN TILES  
Marvel Clauzetto White 75x150  
Marvel Nero Marquina Lappato 75x150  
Marvel Cardoso Elegant Mosaico Bacchetta 30x30

atlas concorde

WALL TILES  
Marvel Cardoso Elegant 50x110  
3D WALL TILES  
Marvel 3D Plot Clauzetto White 50x110  
TRIM TILES  
Marvel Clauzetto White Spigolo 10 mm 1x20  
PORCELAIN TILES  
Marvel Clauzetto White 75x150  
Marvel Cardoso Elegant Mosaico Bacchetta 30x30

atlas concorde

**Three-dimensional ceramic wall tiles blend the allure of sculptured stone with the benefits of ceramics.**  
*Rivestimenti ceramici tridimensionali uniscono il fascino della pietra scolpita ai vantaggi della ceramica.*

Revêtements céramiques tridimensionnels alliant le charme de la pierre gravée aux avantages de la céramique.  
3D-Keramikwandbeläge vereinen die Magie des behauenen Steins mit den Vorzügen der Keramik. Revestimientos cerámicos tridimensionales unen la fascinación de la piedra esculpida con las ventajas de la cerámica. Трехмерная настенная плитка сочетают красивый эффект резного камня с преимуществами керамики.

WALL TILES  
Marvel Cardoso Elegant 50x110  
3D WALL TILES  
Marvel 3D Plot Clauzetto White 50x110  
PORCELAIN TILES  
Marvel Clauzetto White 75x150  
Marvel Nero Marquina Lappato 75x150





**STONE LOOK**

# MOSAICO BACCHETTA

30X30 cm - 11<sup>3</sup>/<sub>4</sub>" x 11<sup>3</sup>/<sub>4</sub>"

*Available in: Clauzetto White, Desert Beige, Cardoso Elegant, Basaltina Volcano*

PORCELAIN TILES DECOR



Marvel Cardoso Elegant Mosaico Bacchetta 30x30

- WALL TILES
- Marvel Cardoso Elegant 50x110
- 3D WALL TILES
- Marvel 3D Plot Clauzetto White 50x110
- TRIM TILES
- Marvel Clauzetto White Spigolo 10mm 1x20
- PORCELAIN TILES
- Marvel Clauzetto White 75x150
- Marvel Cardoso Elegant Mosaico Bacchetta 30x30



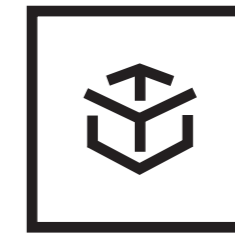

## SHIMMERING ELEGANCE

RAFFINATEZZA RICCA DI RIFLESSI

Exclusively and resplendent marble-look porcelain tiles are used to create hospitality areas and halls in hotels with international flair. The golden, warm palette of Cream Prestige, chosen for coordinated floors and walls, is enhanced by touches of darker colour, to create spaces in a modern elegant style.

*Superfici in gres porcellanato effetto marmo dal carattere prezioso e raffinato consentono di progettare spazi dell'accoglienza e hotel dal design internazionale. La cromia calda e dorata di Cream Prestige, scelta per pavimenti e rivestimenti coordinati, si arricchisce di accenti cromatici scuri, per spazi dallo stile elegante e attuale.*

PROJECT  
HOTEL HALL

LOCATION  
MOSCOW

MARVELSTONE ITEMS  
CREAM PRESTIGE, NERO MARQUINA



PORCELAIN TILES  
Marvel Cream Prestige Lappato 75x150

**RAFFINEMENT DE REFLETS PRÉCIEUX**  
**SCHIMMERNDE ELEGANZ**  
**ELEGANCIA RICA DE REFLEJOS**  
**СИЯЮЩАЯ ЭЛЕГАНТНОСТЬ**

Surfaces en grès cérame effet marbre, au caractère précieux et raffiné, permettant de concevoir des espaces d'accueil et des hôtels au design international. La couleur chaude et dorée de Cream Prestige, choisie pour des sols et des revêtements muraux coordonnés, s'enrichit de touches de couleur foncée, pour des espaces au style élégant et moderne. Oberflächen aus Feinsteinzeug mit Marmoroptik von edlem Charakter erlauben die Planung von Gemeinschaftseinrichtungen und Hotels in internationalem Design. Die warme, goldene Farbgebung von Cream Prestige, die für koordinierte Wand- und Bodenbeläge gewählt wurde, bereichert sich um dunkle Farbakzente für Räume in elegantem und aktuellem Stil. Superficies de Gres porcelánico de efecto mármol de carácter precioso y refinado son ideales para proyectar espacios de acogida y hoteles de diseño internacional. La tonalidad de color cálido y dorado de Cream Prestige, elegida para pavimentos y revestimientos coordinados se enriquecen gracias a sus tonos cromáticos oscuros, para espacios de estilo elegante y actual. Драгоценная керамогранитная плитка под мрамор позволяет роскошно оформлять интерьеры отелей, в каком бы уголке земного шара они ни находились. Теплый золотистый тон Cream Prestige, выбранный для полов и стен, украшен темными цветовыми акцентами, благодаря которым пространства приобретают актуальную элегантность.

**Marble-effect surfaces in warm, richly detailed, natural shades.**  
*Superfici effetto marmo dalla nuance calda e naturale e dai dettagli preziosi.*

Surfaces effet marbre de nuance chaude et naturelle et aux détails précieux. Oberflächen mit Marmoroptik in einer warmen, natürlichen Nuance und mit kostbaren Details. Superficies de efecto mármol de matiz cálido y natural con detalles preciosos. Плитка под мрамор теплого натурального оттенка с драгоценными деталями.

PORCELAIN TILES  
Marvel Cream Prestige Lappato 75x150  
Marvel Nero Marquina Lappato 75x150  
Marvel Mosaico Esagono Geo Warm Lappato 25,4x35,2





atlas concorde

**Rich deep black marble-effect porcelain tiles with a patterns of light coloured veins and swirls.**  
*Gres porcellanato effetto marmo dal nero profondo e corposo disegnato da un gioco di venature chiare.*

Grès cérame effet marbre d'une tonalité noire pleine et profonde, et agrémenté d'un jeu de veinures claires. Feinsteinzeug mit Marmoroptik in tiefem, sattem Schwarz, durch ein Spiel aus hellen Aderungen gezeichnet. Gres porcelánico de efecto mármol de negro profundo y compacto diseñado por un juego de vetas claras. Керамогранит под мрамор глубокого черного цвета, пронизанный светлым прожилковым рисунком.



PORCELAIN TILES  
 Marvel Cream Prestige Lappato 75x150  
 Marvel Nero Marquina Lappato 75x150  
 Marvel Mosaico Esagono Geo Warm Lappato 25,4x35,2



atlas concorde

PORCELAIN TILES  
 Marvel Cream Prestige Lappato 75x150  
 Marvel Nero Marquina Lappato 75x150  
 Marvel Mosaico Esagono Geo Warm Lappato 25,4x35,2  
 Marvel Cream Prestige Mosaico Esagono Lappato 30x35



**MARBLE LOOK**

**MOSAICO ESAGONO GEO**

25,4x35,2 cm - 10"x13<sup>3</sup>/<sub>4</sub>"

*Available in: WARM (Bianco Dolomite + Cream Prestige + Nero Marquina) COLD (Carrara Pure + Bardiglio Grey + Nero Marquina)*

PORCELAIN TILES DECOR



PORCELAIN TILES  
 Marvel Cream Prestige Lappato 75x150  
 Marvel Nero Marquina Lappato 75x150  
 Marvel Cream Prestige Mosaico Esagono Lappato 30x35

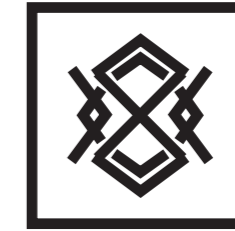

# GLAMOROUS AND LUXURIOUS BACKDROP

ASPETTO PREZIOSO E LUSSUOSO

Brilliant, white-body wall tiles with a mirror-like surface faithfully capture the golden tonalities and sophisticated essence of precious marble. The absolute class of the coordinated floor and wall tiles inspired by warm, natural marble is offset by the decisive contrast in colours when combined with the black Nero Marquina and the many possible decorative elements.

*Brillanti rivestimenti in pasta bianca dalla superficie specchiante riproducono con fedeltà un prezioso marmo dalla tonalità dorata e dall'anima sofisticata. L'estrema eleganza di pavimenti e rivestimenti coordinati, ispirati a un marmo caldo e naturale, è accompagnata dalla nota decisa del contrasto cromatico con il Nero Marquina e dalla raffinatissima gamma decorativa.*

PROJECT  
OPULENT BATHROOM

LOCATION  
ST PETERSBURG

MARVELSTONE ITEMS  
CREAM PRESTIGE, NERO MARQUINA



WALL TILES  
Marvel Cream Prestige 50x110

**ASPECT PRÉCIEUX ET LUXUEUX**  
*EDLES UND LUXURIÖSES AMBIENTE*  
**ASPECTO PRECIOSO Y LUJOSO**  
*ДРАГОЦЕННЫЙ И РОСКОШНЫЙ ВИД*

Revêtements muraux brillants en pâte blanche, à la surface miroitante, reproduisant fidèlement un précieux marbre de tonalité dorée au style sophistiqué. L'extrême élégance des sols et des revêtements muraux coordonnés, inspirés d'un marbre chaud et naturel, est accompagnée de la note vive apportée par le contraste chromatique du Nero Marquina et d'une gamme de décors très raffinés. Glänzende, weißscherbige Wandbeläge mit spiegelblanker Oberfläche bilden einen kostbaren Marmor von goldener Farbe und edler Ausstrahlung nach. Die extreme Eleganz der koordinierten, an einem warmen und natürlichen Marmor inspirierten Wand- und Bodenbeläge wird durch den markanten Farbkontrast mit dem Nero Marquina und dem hocheleganten Dekorangebot noch unterstrichen. Brillantes revestimientos de pasta blanca de superficie reflectante reproducen con fidelidad un precioso mármol de tonalidad dorada y de esencia sofisticada. La máxima elegancia de pavimentos y revestimientos coordinados, inspirados en un mármol cálido y natural, está acompañada por la nota marcada del contraste cromático con el Nero Marquina y por la refinadísima serie decorativa. Зеркально блестящая настенная плитка из белой глины с точностью воспроизводит драгоценный вид мрамора золотистого цвета. Исключительную элегантность напольных и настенных покрытий изящно подчеркивает решительный цветовой контраст с оттенком Nero Marquina и изысканная гамма декоративных элементов.

**An exquisitely elegant mesh-backed mosaic of small high-gloss or satin-finished hexagonal tiles.**  
*Mosaico su rete dall'eleganza ricercata, fatto di tessere esagonali lucide e satiniate.*

Mosaïque sur filet à l'élégance raffinée, faite de tesselles hexagonales brillantes et satinées. Auf Netz verklebtes Mosaik von erlesener Eleganz, aus sechseckigen, glänzenden und matten Mosaiksteinen. Mosaico sobre red de elegancia refinada, hecho de teselas hexagonales brillantes y satinados. Элегантная мозаика из глянцевых и сатирированных шестигранников.

WALL TILES  
Marvel Cream Prestige 50x110  
Marvel Nero Marquina 50x110  
Marvel Cream Prestige Twist 30,5x30,5 cm  
TRIM TILES  
Marvel Nero Marquina Spigolo 0,8x20





atlas concorde

**Exquisite marble-look tiles in warm and natural shades for uniquely beautiful and stylish tiles.**  
*Prezioso effetto marmo dalle nuance calde e naturali per superfici dall'estetica unica e sofisticata.*

Précieux effet marbre aux nuances chaudes et naturelles pour des surfaces à l'esthétisme unique et sophistiqué. Kostbare Marmoroptik in warmen und natürlichen Nuancen für Oberflächen von unvergleichlicher, edler Schönheit. Prezioso efecto mármol de matices cálidos y naturales para superficies de estética única y sofisticada. Драгоценная мраморная фактура теплых натуральных оттенков для изысканных покрытий.

WALL TILES  
 Marvel Cream Prestige 50x110  
 Marvel Nero Marquina 50x110  
 TRIM TILES  
 Marvel Cream Prestige Spigolo 0,8x20  
 PORCELAIN TILES  
 Marvel Cream Prestige Lappato 75x150



atlas concorde

WALL TILES  
 Marvel Cream Prestige 50x110  
 Marvel Nero Marquina 50x110  
 Marvel Cream Prestige Twist 30,5x30,5 cm  
 TRIM TILES  
 Marvel Nero Marquina Spigolo 0,8x20  
 PORCELAIN TILES  
 Marvel Cream Prestige Lappato 75x150  
 Marvel Nero Marquina Lappato 45x90



atlasconcorde

**Inspired by the deep intense colour of black marble offset by white veins, for a total black look.**  
*Inspirato a un marmo nero dal colore intenso e ricco di vene bianche a contrasto, per un total black dalla forte personalità.*

*S'inspirant d'un marbre noir d'une tonalité intense et enrichi de veines blanches en contraste, pour un total black de grand caractère. Inspiriert an einem tiefschwarzen Marmor mit zahlreichen weißen, kontrastierenden Adern. Erzeugt ein Total Black mit starker Persönlichkeit. Inspirado en un mármol negro de color intenso y rico de venas blancas en contraste, para un negro total de fuerte personalidad. Мраморная фактура насыщенно-черного цвета с белыми контрастными прожилками для эффектного дизайна в стиле тотал-блэк.*

## MARBLE LOOK

### TWIST

30,5x30,5 cm - 12"x12"

**Available in:** Carrara Pure, Bianco Dolomite, Bardiglio Grey, Cream Prestige, Nero Marquina

WALLTILESDECOR



atlasconcorde

Marvel Cream Prestige Twist 30,5x30,5 cm



WALL TILES  
 Marvel Cream Prestige Twist 30,5x30,5 cm  
 PORCELAIN TILES  
 Marvel Nero Marquina Lappato 45x90

**MARBLE LOOK**

**BASKETWEAVE**

30x30 cm - 11<sup>3</sup>/<sub>4</sub>"x11<sup>3</sup>/<sub>4</sub>"

Available in: WARM (Cream Prestige + Nero Marquina) COLD (Carrara Pure + Nero Marquina)

PORCELAIN TILES DECOR

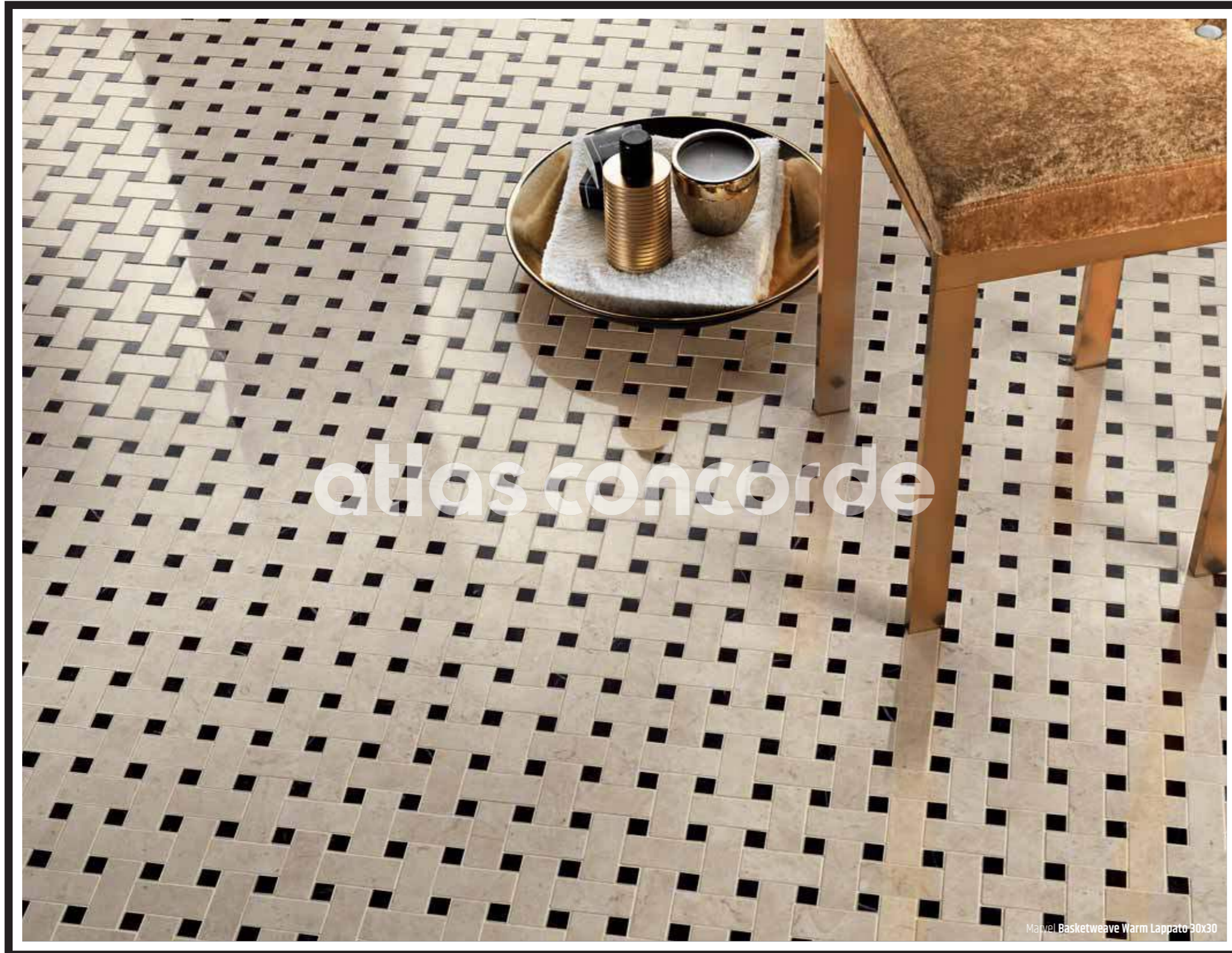

Marvel Basketweave Warm Lappato 30x30



Marvel Greca Gold 7,8x30,5

**MARBLE LOOK**

**GRECA GOLD**

7,8x30,5 cm - 3<sup>1</sup>/<sub>8</sub>"x12"

WALL TILES DECOR

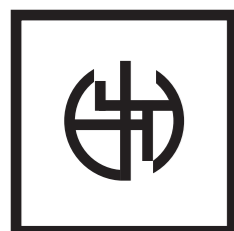

# SUPERBLY SOPHISTICATED INSPIRATIONS

ISPIRAZIONI ESTREMAMENTE  
SOFISTICATE

**Spectacularly large 120x240 cm (47<sup>1</sup>/<sub>4</sub>"x 94<sup>1</sup>/<sub>2</sub>" ) stone-look porcelain tiles maximize great contemporary spaces. The distinctive palette of modern and versatile greys in tiles inspired by soft pearl-coloured stone adorns large surfaces and spaces, matching elegant, marble-effect walls.**

*Grandi e scenografiche lastre in gres porcellanato effetto pietra in 120x240 cm valorizzano contemporanei contesti dell'ospitalità di ampie dimensioni. Superfici ispirate a una pietra grigio perla incontrano ampi rivestimenti e volumi in una particolare cadenza di grigio moderno e versatile, affiancandosi a eleganti pareti effetto marmo.*

M+S

PROJECT  
SPA HALL

LOCATION  
BERLIN

MARVELSTONE ITEMS  
CLAUZETTO WHITE, CARDOSO ELEGANT, CARRARA PURE





atlas concorde

**INSPIRATIONS EXTRÊMEMENT SOPHISTIQUÉES**  
*EXTREM EDLE INSPIRATIONEN*  
**INSPIRACIONES EXTREMADAMENTE SOFISTICADAS**  
*ИСКЛЮЧИТЕЛЬНАЯ ИЗЫСКАННОСТЬ*

Grandes dalles scénographiques en grès cérame effet pierre, au format 120x240 cm, pour valoriser les espaces d'accueil contemporains de grandes dimensions. Les surfaces s'inspirant d'une pierre gris perle épousent de grands revêtements et volumes dans une cadence particulière d'un gris moderne et éclectique, en épousant l'élégance des murs effet marbre. Große, szenografische Platten aus Feinsteinzeugfliesen mit Steinoptik im Format 120x240 cm werten zeitgenössische, großzügig angelegte Hospitality-Einrichtungen auf. An einem perlgrauen Stein inspirierte Flächen treffen auf Wandbeläge und Volumen in einem besonderen, modernen und vielseitigen Grauton der eleganten, in Marmoroptik gehaltenen Wände. Grandes y escenográficas placas de gres porcelánico de efecto piedra de 120x240 cm valorizan contemporáneos contextos de hospitalidad de gran tamaño. Superficies inspiradas en una piedra gris perla concurren en amplios revestimientos y volúmenes en una particular entonación de gris moderno y versátil, encontrando elegantes paredes de efecto mármol. Роскошные керамогранитные плиты под камень 120x240 см идеальны для современного оформления просторных интерьеров, где бывает большое количество гостей. Красивая фактура камня жемчужно-серого цвета стильно сочетается с элегантными настенными покрытиями под мрамор.

**In vertical walls installation, the maxi porcelain stoneware slab format means being able to cover an entire wall with one single slab.**  
*Nella posa verticale, il maxi formato in gres porcellanato consente di rivestire la parete con un'unica lastra.*

Dans la pose verticale, le maxi format en grès cérame permet de revêtir le mur avec une seule dalle. Vertikal verlegt kann mit dem Maxi Format aus Feinsteinzeug die gesamte Wand mit einer einzigen Platte abgedeckt werden. En la colocación vertical, el maxi formato en gres porcelánico permite revestir la pared con una losa única. При вертикальной укладке макси-формат позволяет покрывать стену снизу доверху одной единственной плитой.

PORCELAIN TILES  
 Marvel Clauzetto White 120x240  
 Marvel Cardoso Elegant 120x240  
 Marvel Carrara Pure Lappato 120x240



atlas concorde

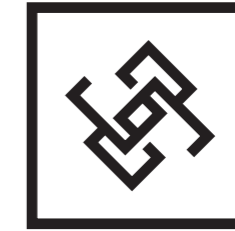

# NATURAL AND CONTEMPORARY APPEAL

TOCCO NATURALE E CONTEMPORANEO

Splendid large porcelain tiles replicating marble and stone can maximise projects for contemporary spaces of spectacular effect. Available in large sizes, 120x120 (47<sup>1</sup>/<sub>4</sub>"x 47<sup>1</sup>/<sub>4</sub>"") and 120x240 cm (47<sup>1</sup>/<sub>4</sub>"x 94<sup>1</sup>/<sub>2</sub>""), the majestic porcelain tiles surfaces will give that extra touch of style to walls and floors.

*Spettacolari grandi lastre in gres porcellanato effetto marmo e pietra valorizzano la progettazione di spazi contemporanei dal carattere scenografico. Disponibili nei grandi formati 120x120 e 120x240 cm, maestose superfici in gres porcellanato rappresentano elementi d'arredo per uso a pavimento e rivestimento.*

PROJECT  
SPA

LOCATION  
KÖLN

MARVELSTONE ITEMS  
BIANCO DOLOMITE, BASALTINA VOLCANO

M+S



**TOUCHE NATURELLE ET CONTEMPORAINE**  
**NATÜRLICHER, ZEITGENÖSSISCHER CHARME**  
**TOQUE NATURAL Y CONTEMPORÁNEO**  
**НАТУРАЛЬНАЯ СОВРЕМЕННАЯ ПРИВЛЕКАТЕЛЬНОСТЬ**

D'extraordinaires grandes dalles en grès cérame effet marbre et pierre valorisent la conception d'espaces contemporains au caractère scénographique. Disponibles dans les grands formats 120x120 et 120x240 cm, ces majestueuses surfaces en grès cérame constituent des éléments de décoration pour sols et murs. Spektakuläre, große Platten aus Feinsteinzeug mit Marmor- und Steinoptik werten Projekte zeitgenössischer Räume mit szenografischer Wirkung auf. Lieferbar in den Großformaten 120x120 und 120x240 cm, majestätische Oberflächen aus Feinsteinzeug als Gestaltungselemente für Wand und Boden. Espectaculares placas grandes de gres porcelánico de efecto mármol y piedra valoriza el proyecto de espacios contemporáneos de carácter escenográfico. Disponibles en los tamaños grandes 120x120 y 120x240 cm, majestuosas superficies de gres porcelánico representan elementos de decoración para uso en pavimento y revestimiento. Великолепные керамогранитные плиты под мрамор и камень позволяют придать современным пространствам роскошную оригинальность. Доступны эти величавые плиты в форматах 120x120 и 120x240 см и подходят для стильного оформления как полов, так и стен.

*The maxi porcelain stoneware slabs mean being able to dress pieces of furniture: tables, panels, worktops.*

*Le maxi lastre in gres porcellanato consentono di rivestire elementi d'arredo: tavoli, quinte, piani da lavoro.*

Les maxi dalles en grès cérame permettent de revêtir des éléments de décoration : tables, coulisses, plans de travail. Die Maxi Platten aus Feinsteinzeug gestalten Einrichtungs-elemente: Tische, Wandflächen, Arbeitsplatten. Le maxi lastre in gres porcelánico permiten revestir elementos de decoración: mesas, mamparas, planos de trabajo. Макси-плитами из керамогранита можно оформлять предметы обстановки: перегородки, столы, стойки.

PORCELAIN TILES  
 Marvel Bianco Dolomite Lappato 120x120 | 120x240  
 Marvel Basaltina Volcano 120x240  
 Marvel Bianco Dolomite Mosaico Esagono 3D 28,2x35,3

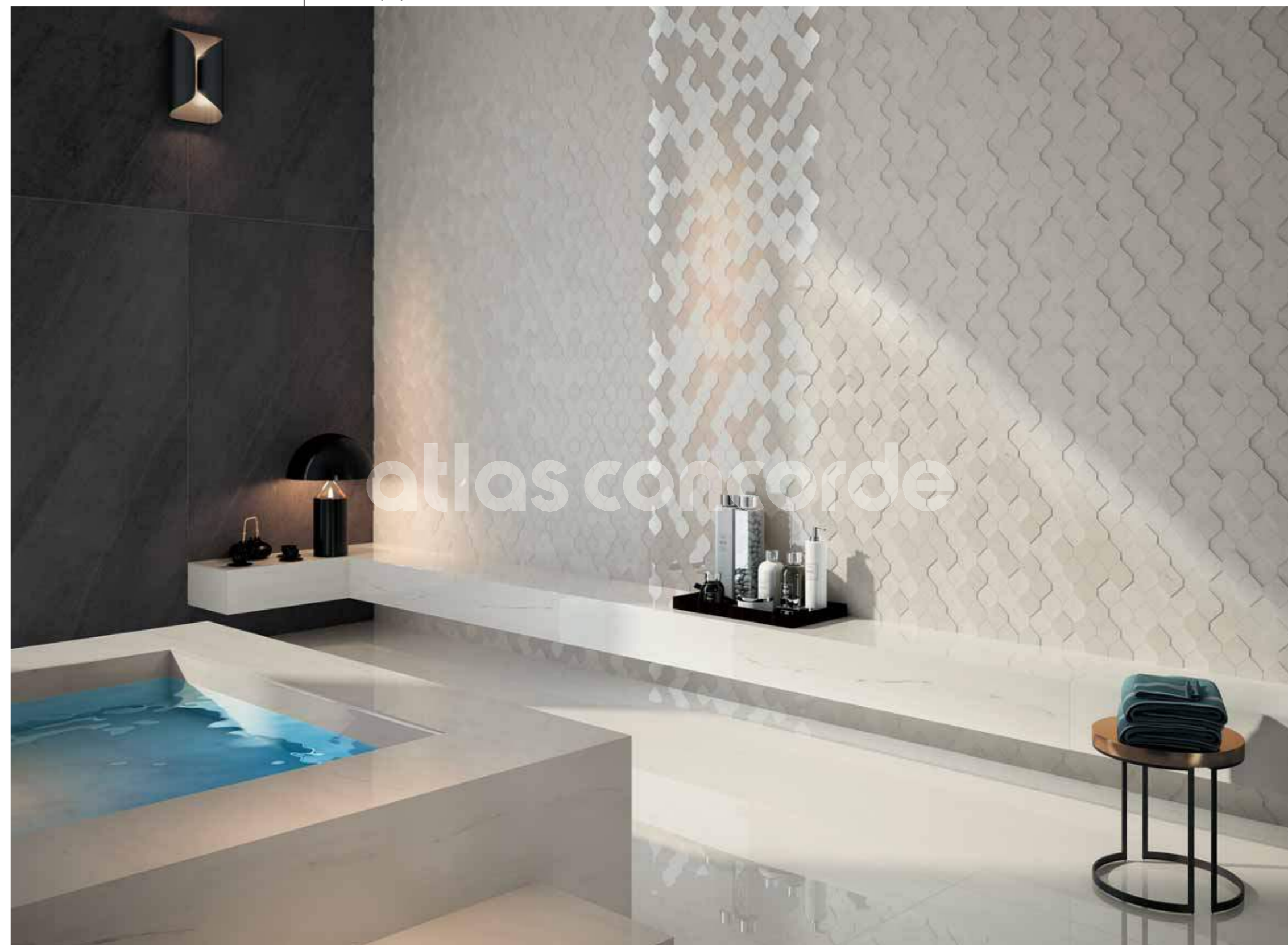

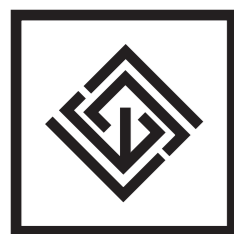

# SCENIC INDOORS AND OUTDOORS

INTERNI ED ESTERNI ESPRESSIVI

Stone-effect porcelain tiles proposed in various sizes and finishes to design indoor and outdoor living spaces in a contemporary style. The warm and natural beauty typical of sand-coloured stone is faithfully interpreted in 2 cm (3/4") thick porcelain tiles for outdoor use.

*Il gres porcellanato effetto pietra è proposto in diversi formati e finiture per progettare spazi abitativi interni ed esterni dallo stile contemporaneo. Pavimenti per esterni in gres porcellanato in 2 cm di spessore interpretano con realismo l'estetica calda e naturale della pietra nella originale tonalità beige.*

**M+S**

PROJECT  
INGOUT VILLA

LOCATION  
SYDNEY

MARVELSTONE ITEMS  
DESERT BEIGE, NERO MARQUINA

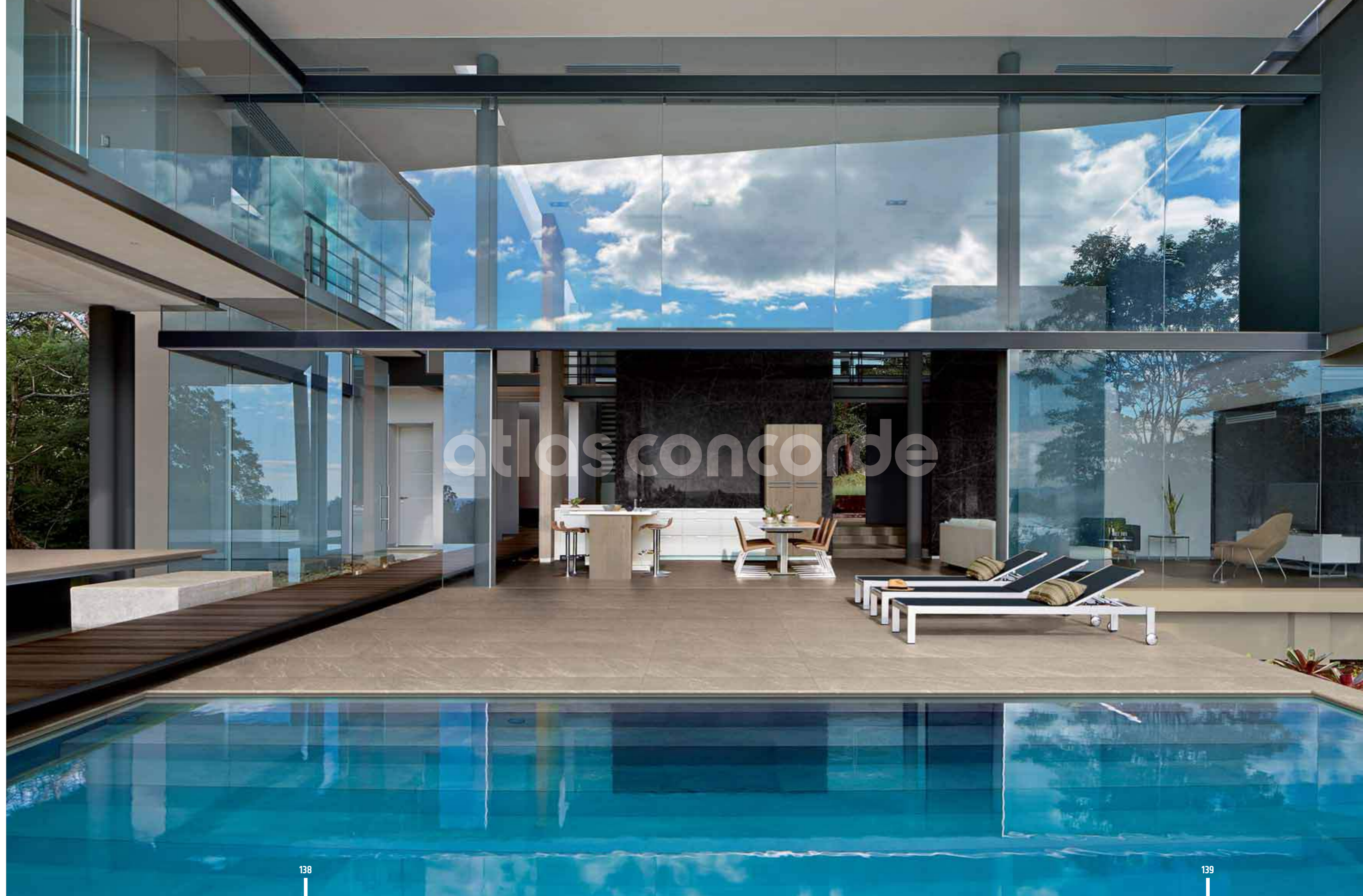



**INTÉRIEUR ET EXTÉRIEUR TRÈS SUGGESTIFS**  
**AUSDRUCKSSTARKE INNEN- UND AUSSENBEREICHE**  
**INTERIORES Y EXTERIORES EXPRESIVOS**  
**ВЫРАЗИТЕЛЬНЫЕ ВНУТРЕННИЕ И НАРУЖНЫЕ ПРОСТРАНСТВА**

Le grès cérame effet pierre est proposé dans plusieurs formats et finitions pour concevoir l'intérieur et l'extérieur d'espaces d'habitation au style contemporain. Sols d'extérieur en grès cérame de 2 cm d'épaisseur qui interprètent avec réalisme l'esthétisme chaud et naturel de la pierre dans une tonalité beige originale. Das Feinsteinzeug mit Steinoptik wird in verschiedenen Formaten und Oberflächenbearbeitungen angeboten, um Innen- und Außenbereiche in Wohnbereichen in modernem Stil zu gestalten. Bodenbeläge für Außenbereiche aus Feinsteinzeug in 2 cm Stärke interpretieren auf naturgetreue Weise die warme und natürliche Schönheit des Natursteins in seinem originalen Beige-Ton. El grés porcelánico de efecto piedra se propone en diferentes tamaños y acabados para proyectar espacios interiores y exteriores dedicados a la vivienda de estilo contemporáneo. Pavimentos para exteriores de grés porcelánico de 2 cm de grosor interpretan con realismo la estética cálida y natural de la piedra en la original tonalidad beige. Керамогранит под камень разных форматов и с разными поверхностями задуман для современного оформления внутренних и наружных пространств дома. Уличная плитка толщиной 2 см с изумительным реализмом воспроизводит теплую и натуральную фактуру камня в оригинальном варианте бежевого цвета.



PORCELAIN TILES  
 Marvel Desert Beige 60x120 LASTRA 20 mm  
 Marvel Desert Beige 75x150  
 Marvel Nero Marquina Lappato 75x150  
 Marvel Desert Beige Brick 30x60  
 Etic Pro Eucalipto Smoked 30x120 LASTRA 20 mm  
 TRIM TILES 20mm  
 Marvel Desert Beige Round SP 33x120

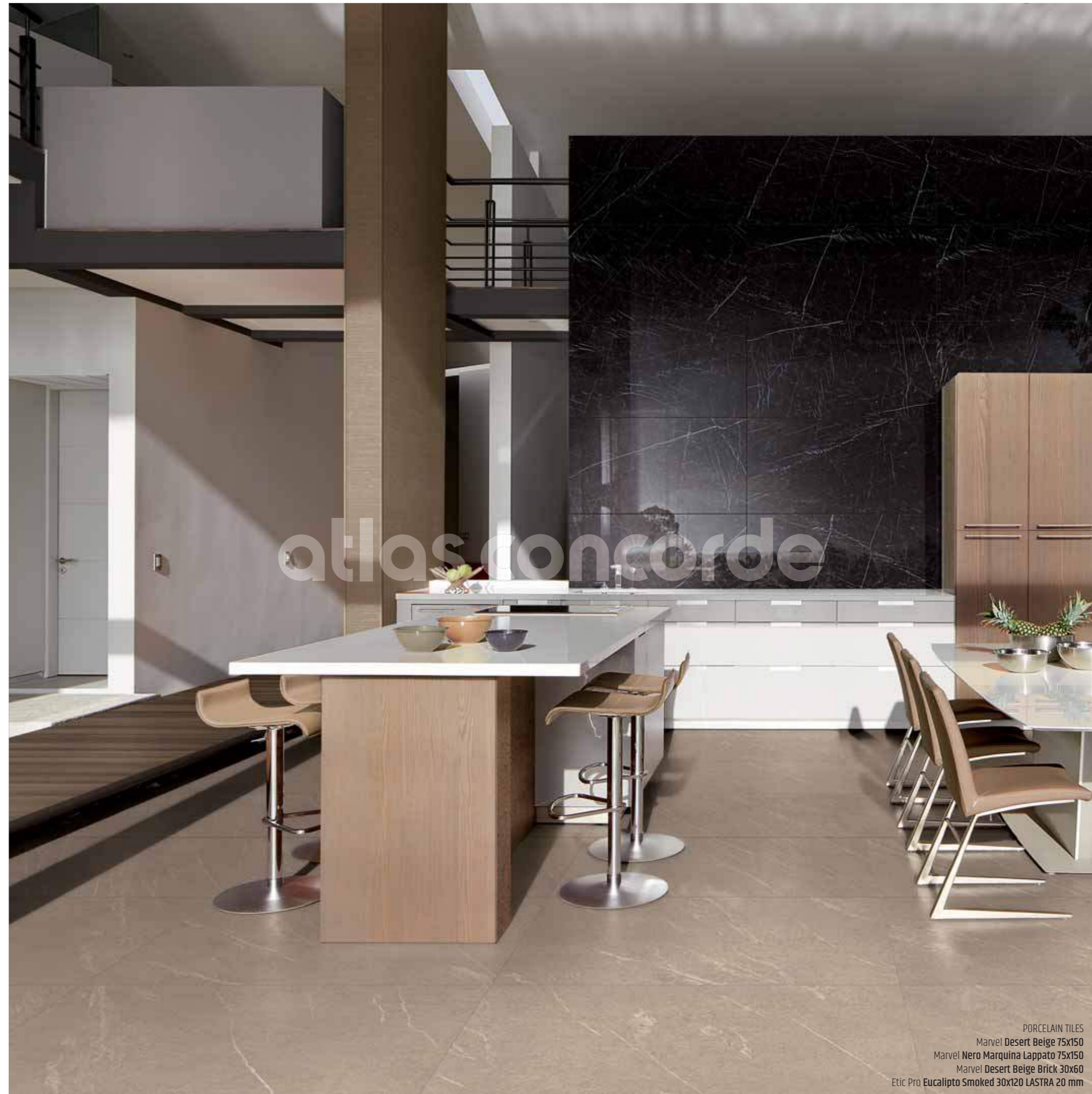

PORCELAIN TILES  
 Marvel Desert Beige 75x150  
 Marvel Nero Marquina Lappato 75x150  
 Marvel Desert Beige Brick 30x60  
 Etic Pro Eucalipto Smoked 30x120 LASTRA 20 mm



**Stone-effect porcelain tiles in various sizes and finishes are used to design interior and exterior spaces with continuity.**

*Il gres porcellanato effetto pietra in diversi formati e finiture consente di progettare interni ed esterni contemporanei senza soluzione di continuità.*

Le grès cérame effet pierre dans plusieurs formats et finitions permet de concevoir des intérieurs et extérieurs contemporains sans solution de continuité. Das Feinsteinzeug mit Steinoptik in verschiedenen Formaten und Oberflächenbearbeitungen erlaubt die Planung zeitgemäßer, kontinuierlich ineinander übergehender Innen- und Außenbereiche. El gres porcelánico de efecto piedra de diferentes tamaños y acabados es ideal para proyectar interiores y exteriores contemporáneos sin solución de continuidad. Керамогранит под камень разных форматов и с разными вариантами поверхности служит красивым связующим элементом между интерьером дома и уличными пространствами. Дизайн в стиле тотал-блэк.



PORCELAIN TILES  
Marvel Desert Beige 75x150  
Marvel Nero Marquina Lappato 75x150  
Marvel Desert Beige 60x120 LASTRA 20 mm



PORCELAIN TILES  
Marvel Desert Beige 75x150  
Marvel Nero Marquina Lappato 75x150  
Marvel Desert Beige Brick 30x60  
Marvel Desert Beige 60x120 LASTRA 20 mm  
Etic Pro Eucalpto Smoked 30x120 LASTRA 20 mm



Marvel Carrara Pure 110  
50x110 cm - 19<sup>5</sup>/<sub>8</sub>"x43<sup>1</sup>/<sub>4</sub>"



Marvel Carrara Pure 80  
40x80 cm - 15<sup>3</sup>/<sub>4</sub>"x31<sup>1</sup>/<sub>2</sub>"



Marvel Bardiglio Grey 110  
50x110 cm - 19<sup>5</sup>/<sub>8</sub>"x43<sup>1</sup>/<sub>4</sub>"



Marvel Bardiglio Grey 80  
40x80 cm - 15<sup>3</sup>/<sub>4</sub>"x31<sup>1</sup>/<sub>2</sub>"

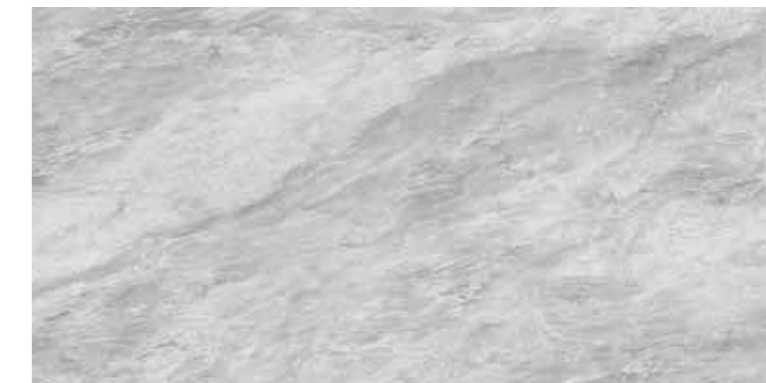

Marvel Bianco Dolomite 110  
50x110 cm - 19<sup>5</sup>/<sub>8</sub>"x43<sup>1</sup>/<sub>4</sub>"



Marvel Bianco Dolomite 80  
40x80 cm - 15<sup>3</sup>/<sub>4</sub>"x31<sup>1</sup>/<sub>2</sub>"



Marvel Nero Marquina 110  
50x110 cm - 19<sup>5</sup>/<sub>8</sub>"x43<sup>1</sup>/<sub>4</sub>"



Marvel Nero Marquina 80  
40x80 cm - 15<sup>3</sup>/<sub>4</sub>"x31<sup>1</sup>/<sub>2</sub>"

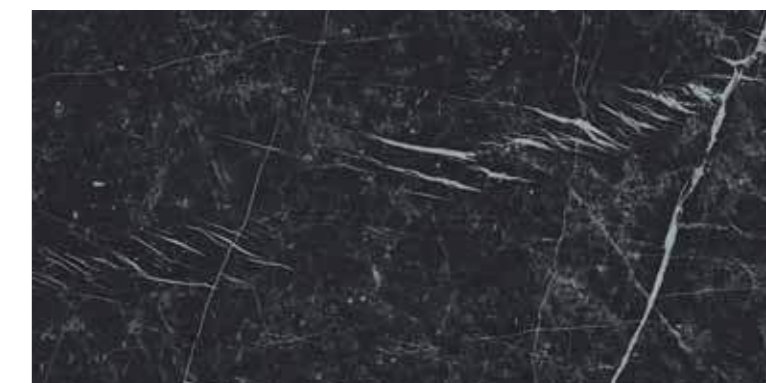

Marvel Cream Prestige 110  
50x110 cm - 19<sup>5</sup>/<sub>8</sub>"x43<sup>1</sup>/<sub>4</sub>"



Marvel Cream Prestige 80  
40x80 cm - 15<sup>3</sup>/<sub>4</sub>"x31<sup>1</sup>/<sub>2</sub>"



Marvel Carrara Pure London  
5x30,5 cm - 2"x12"



Marvel Carrara Pure Spigolo  
0,8x20 cm - 3/8"x7<sup>7</sup>/<sub>8</sub>"



Marvel Bianco Dolomite London  
5x30,5 cm - 2"x12"



Marvel Bianco Dolomite Spigolo  
0,8x20 cm - 3/8"x7<sup>7</sup>/<sub>8</sub>"



London A.E.  
5x2,5 cm - 2"x1"



Spigolo A.E.  
0,8x0,8 cm - 3/8"x3/8"



London A.E.  
5x2,5 cm - 2"x1"



Spigolo A.E.  
0,8x0,8 cm - 3/8"x3/8"



Marvel Cream Prestige London  
5x30,5 cm - 2"x12"



Marvel Cream Prestige Spigolo  
0,8x20 cm - 3/8"x7<sup>7</sup>/<sub>8</sub>"



Marvel Bardiglio Grey London  
5x30,5 cm - 2"x12"



Marvel Bardiglio Grey Spigolo  
0,8x20 cm - 3/8"x7<sup>7</sup>/<sub>8</sub>"



London A.E.  
5x2,5 cm - 2"x1"



Spigolo A.E.  
0,8x0,8 cm - 3/8"x3/8"



London A.E.  
5x2,5 cm - 2"x1"



Spigolo A.E.  
0,8x0,8 cm - 3/8"x3/8"



Marvel Nero Marquina London  
5x30,5 cm - 2"x12"



Marvel Nero Marquina Spigolo  
0,8x20 cm - 3/8"x7<sup>7</sup>/<sub>8</sub>"



London A.E.  
5x2,5 cm - 2"x1"



Spigolo A.E.  
0,8x0,8 cm - 3/8"x3/8"



**MOSAIC Q** 

**Marvel Carrara Pure Mosaic Q**  
30,5x30,5 cm - 12"x12"

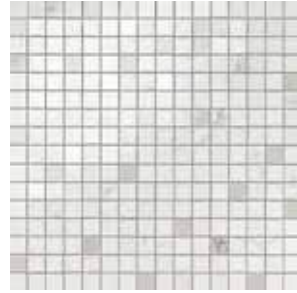

**Marvel Bianco Dolomite Mosaic Q**  
30,5x30,5 cm - 12"x12"

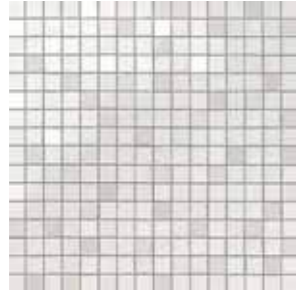

**Marvel Cream Prestige Mosaic Q**  
30,5x30,5 cm - 12"x12"

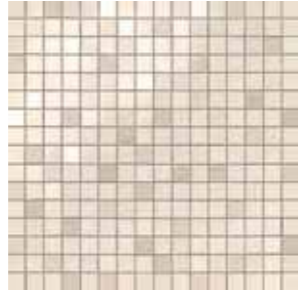

**Marvel Bardiglio Grey Mosaic Q**  
30,5x30,5 cm - 12"x12"

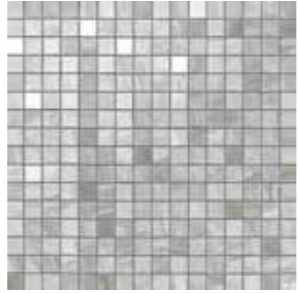

**Marvel Nero Marquina Mosaic Q**  
30,5x30,5 cm - 12"x12"

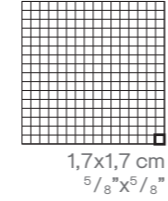
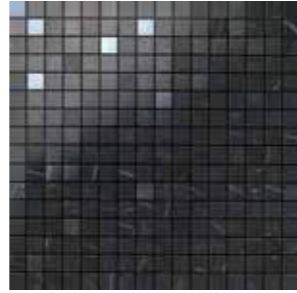

**HERRINGBONE WALL** 

**Marvel Carrara Pure Herringbone Wall**  
30,5x30 cm - 12"x11<sup>3</sup>/<sub>4</sub>"



**Marvel Bianco Dolomite Herringbone Wall**  
30,5x30 cm - 12"x11<sup>3</sup>/<sub>4</sub>"



**Marvel Cream Prestige Herringbone Wall**  
30,5x30 cm - 12"x11<sup>3</sup>/<sub>4</sub>"



**Marvel Bardiglio Grey Herringbone Wall**  
30,5x30 cm - 12"x11<sup>3</sup>/<sub>4</sub>"



**Marvel Nero Marquina Herringbone Wall**  
30,5x30 cm - 12"x11<sup>3</sup>/<sub>4</sub>"



**TWIST** 

**Marvel Carrara Pure Twist**  
30,5x30,5 cm - 12"x12"



**Marvel Bianco Dolomite Twist**  
30,5x30,5 cm - 12"x12"



**Marvel Cream Prestige Twist**  
30,5x30,5 cm - 12"x12"



**Marvel Bardiglio Grey Twist**  
30,5x30,5 cm - 12"x12"



**Marvel Nero Marquina Twist**  
30,5x30,5 cm - 12"x12"

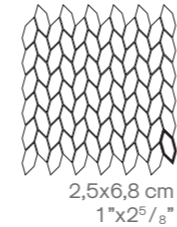

**CHEVRON WALL** 

**Marvel Carrara Pure Chevron Wall**  
30,5x25 cm - 12"x9<sup>7</sup>/<sub>8</sub>"



**Marvel Bianco Dolomite Chevron Wall**  
30,5x25 cm - 12"x9<sup>7</sup>/<sub>8</sub>"



**Marvel Nero Marquina Chevron Wall**  
30,5x25 cm - 12"x9<sup>7</sup>/<sub>8</sub>"



**Marvel Chevron Cold Wall**  
30,5x25 cm - 12"x9<sup>7</sup>/<sub>8</sub>"



*Carrara Pure + Nero Marquina*

**Marvel Chevron Warm Wall**  
30,5x25 cm - 12"x9<sup>7</sup>/<sub>8</sub>"



*Bianco Dolomite + Nero Marquina*

**Marvel Chevron Mix Wall**  
30,5x25 cm - 12"x9<sup>7</sup>/<sub>8</sub>"



*Carrara Pure + Bardiglio Grey + Nero Marquina*

**GRECA**

**Marvel Greca Gold**  
7,8x30,5 cm - 3<sup>1</sup>/<sub>8</sub>"x12"



**Marvel Greca A.E.**  
7,8x1,2 cm - 3<sup>1</sup>/<sub>8</sub>"x<sup>3</sup>/<sub>8</sub>"



**Marvel Gold Black**  
7,8x30,5 cm - 3<sup>1</sup>/<sub>8</sub>"x12"



**Marvel Gold Black A.E.**  
7,8x1,2 cm - 3<sup>1</sup>/<sub>8</sub>"x<sup>3</sup>/<sub>8</sub>"



**Marvel Gold White**  
7,8x30,5 cm - 3<sup>1</sup>/<sub>8</sub>"x12"



**Marvel Gold White A.E.**  
7,8x1,2 cm - 3<sup>1</sup>/<sub>8</sub>"x<sup>3</sup>/<sub>8</sub>"



**HONED SURFACE**   

120x240 cm - 47<sup>1</sup>/<sub>4</sub>"x94<sup>1</sup>/<sub>2</sub>"

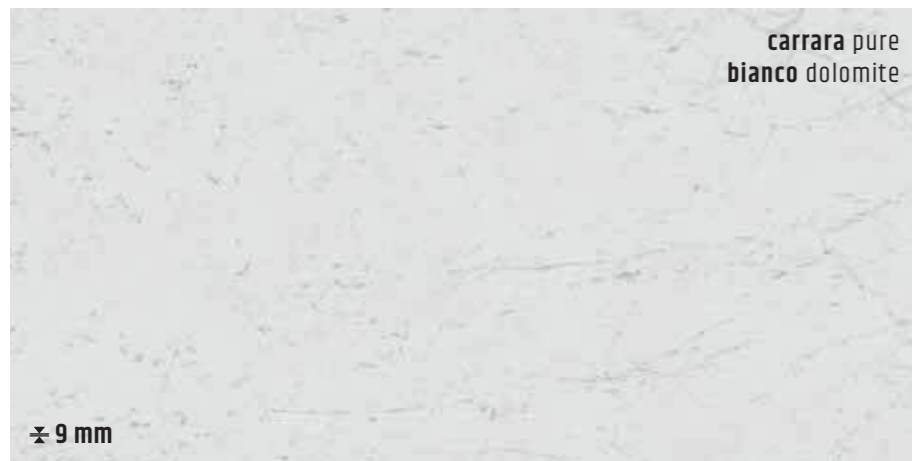

120x120 cm - 47<sup>1</sup>/<sub>4</sub>"x47<sup>1</sup>/<sub>4</sub>"



75x150 cm - 29<sup>1</sup>/<sub>2</sub>"x59"



75x75 cm - 29<sup>1</sup>/<sub>2</sub>"x29<sup>1</sup>/<sub>2</sub>"



60x60 cm - 23<sup>5</sup>/<sub>8</sub>"x23<sup>5</sup>/<sub>8</sub>"



45x90 cm - 17<sup>3</sup>/<sub>4</sub>"x35<sup>3</sup>/<sub>8</sub>"



30x60 cm - 11<sup>3</sup>/<sub>4</sub>"x23<sup>5</sup>/<sub>8</sub>"

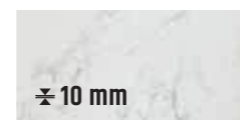

**MATT SURFACE**   

60x60 cm - 23<sup>5</sup>/<sub>8</sub>"x23<sup>5</sup>/<sub>8</sub>"

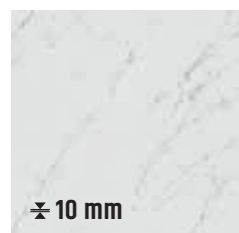

45x90 cm - 17<sup>3</sup>/<sub>4</sub>"x35<sup>3</sup>/<sub>8</sub>"



30x60 cm - 11<sup>3</sup>/<sub>4</sub>"x23<sup>5</sup>/<sub>8</sub>"

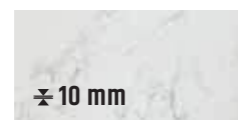

**DESTINATIONS OF USE / DESTINAZIONI D'USO**



**MEDIUM TRAFFIC**  
CALPESTIO MEDIO

MODERATE COMMERCIAL AREAS  
(restaurants, offices, showrooms, public restrooms, public offices, hotels, business lounges, etc. save for obligated pathways)

COMMERCIALI MEDI (ristoranti, uffici, negozi, bagni pubblici, uffici pubblici, hotel, business lounge, etc. a esclusione di passaggi obbligati)

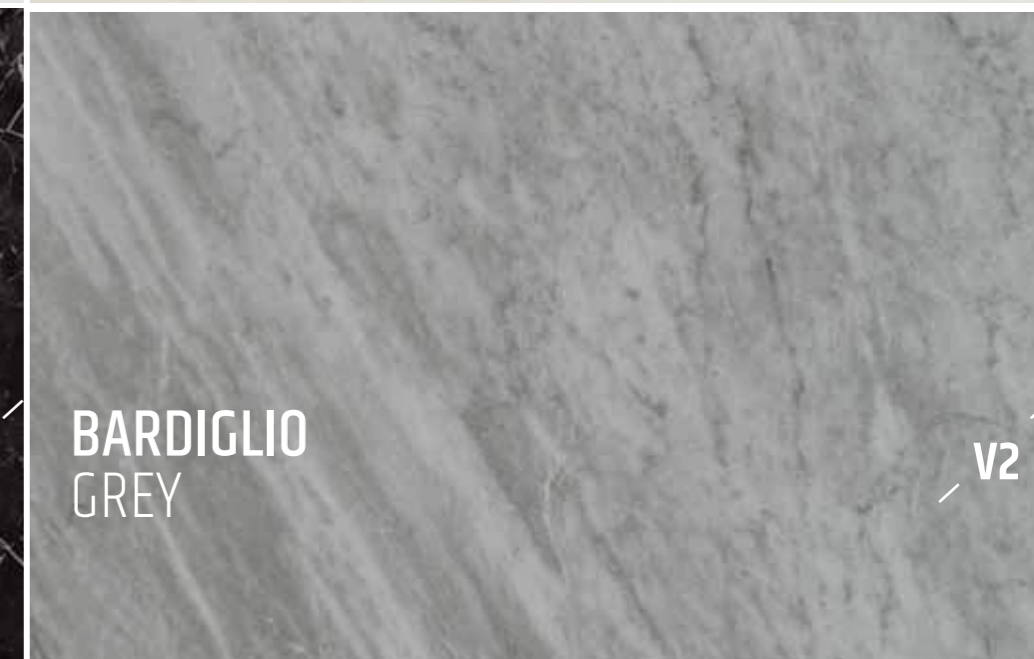
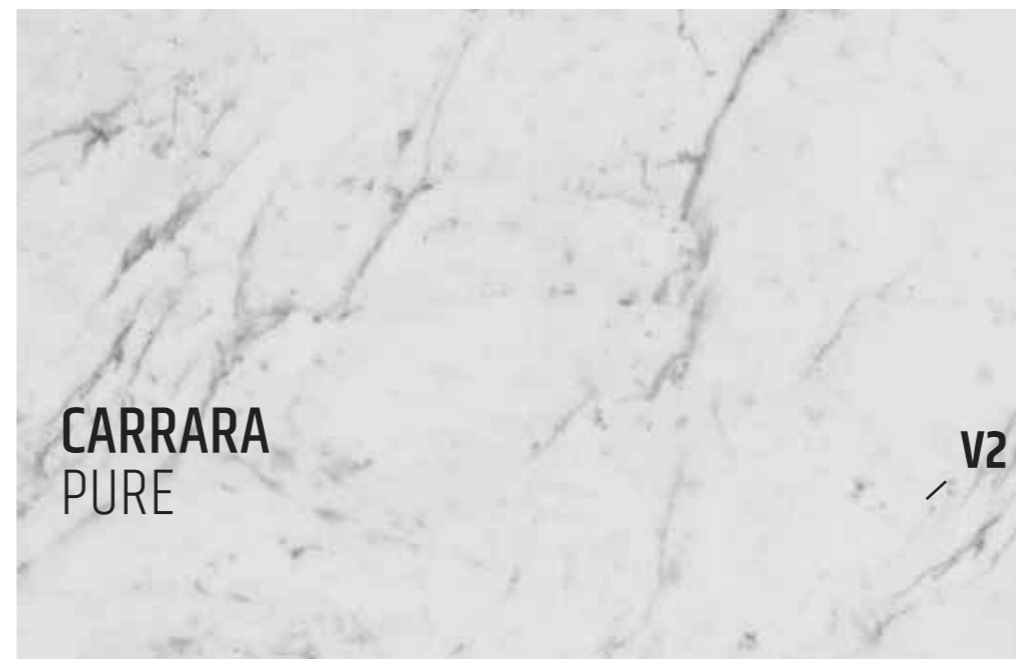

**MOSAICO ESAGONO LAPPATO**

Marvel Carrara Pure  
Mosaico Esagono Lappato  
30x35 cm - 11<sup>3</sup>/<sub>4</sub>"x13<sup>3</sup>/<sub>4</sub>"



Marvel Bianco Dolomite  
Mosaico Esagono Lappato  
30x35 cm - 11<sup>3</sup>/<sub>4</sub>"x13<sup>3</sup>/<sub>4</sub>"



Marvel Cream Prestige  
Mosaico Esagono Lappato  
30x35 cm - 11<sup>3</sup>/<sub>4</sub>"x13<sup>3</sup>/<sub>4</sub>"



Marvel Bardiglio Grey  
Mosaico Esagono Lappato  
30x35 cm - 11<sup>3</sup>/<sub>4</sub>"x13<sup>3</sup>/<sub>4</sub>"



Marvel Nero Marquina  
Mosaico Esagono Lappato  
30x35 cm - 11<sup>3</sup>/<sub>4</sub>"x13<sup>3</sup>/<sub>4</sub>"

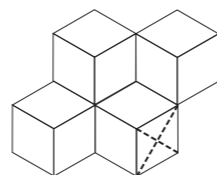

10x17 cm  
3<sup>7</sup>/<sub>8</sub>"x6<sup>3</sup>/<sub>4</sub>"

**CHEVRON LAPPATO**

Marvel Carrara Pure  
Chevron Lappato  
22,5x22,9 cm - 8<sup>3</sup>/<sub>4</sub>"x9"



Marvel Bianco Dolomite  
Chevron Lappato  
22,5x22,9 cm - 8<sup>3</sup>/<sub>4</sub>"x9"



Marvel Cream Prestige  
Chevron Lappato  
22,5x22,9 cm - 8<sup>3</sup>/<sub>4</sub>"x9"



Marvel Bardiglio Grey  
Chevron Lappato  
22,5x22,9 cm - 8<sup>3</sup>/<sub>4</sub>"x9"



Marvel Nero Marquina  
Chevron Lappato  
22,5x22,9 cm - 8<sup>3</sup>/<sub>4</sub>"x9"

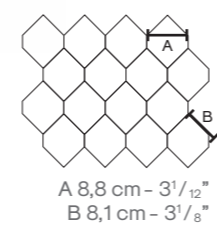

A 8,8 cm - 3<sup>1</sup>/<sub>2</sub>"  
B 8,1 cm - 3<sup>1</sup>/<sub>8</sub>"

**MOSAICO ESAGONO 3D**

Marvel Carrara Pure  
Mosaico Esagono 3D  
28,2x35,3 cm - 11"x14"



Marvel Bianco Dolomite  
Mosaico Esagono 3D  
28,2x35,3 cm - 11"x14"



Marvel Cream Prestige  
Mosaico Esagono 3D  
28,2x35,3 cm - 11"x14"



Marvel Bardiglio Grey  
Mosaico Esagono 3D  
28,2x35,3 cm - 11"x14"



Marvel Nero Marquina  
Mosaico Esagono 3D  
28,2x35,3 cm - 11"x14"



**MOSAICO ESAGONO GEO LAPPATO**

Marvel Mosaico Esagono Geo  
Cold Lappato  
25,4x35,2 cm - 10"x13<sup>3</sup>/<sub>4</sub>"



Carrara Pure + Bardiglio Grey + Nero Marquina

Marvel Mosaico Esagono Geo  
Warm Lappato  
25,4x35,2 cm - 10"x13<sup>3</sup>/<sub>4</sub>"



Bianco Dolomite + Cream Prestige + Nero Marquina

**CHEVRON COLD LAPPATO**

Marvel Chevron Cold Lappato  
22,5x22,9 cm - 8<sup>3</sup>/<sub>4</sub>"x9"



Carrara Pure + Nero Marquina

**BASKETWEAVE LAPPATO**

Marvel Basketweave Cold Lappato  
30x30 cm - 11<sup>3</sup>/<sub>4</sub>"x11<sup>3</sup>/<sub>4</sub>"



Carrara Pure + Nero Marquina

Marvel Basketweave Warm Lappato  
30x30 cm - 11<sup>3</sup>/<sub>4</sub>"x11<sup>3</sup>/<sub>4</sub>"



Cream Prestige + Nero Marquina

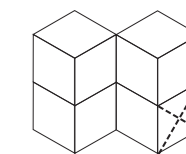

10x17 cm  
3<sup>7</sup>/<sub>8</sub>"x6<sup>3</sup>/<sub>4</sub>"

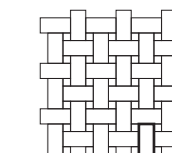

6,7x2,9 cm  
2<sup>5</sup>/<sub>8</sub>"x1<sup>1</sup>/<sub>8</sub>"  
1,7x1,7 cm  
5<sup>5</sup>/<sub>8</sub>"x5<sup>5</sup>/<sub>8</sub>"

**HALF HEX LAPPATO**

Marvel Half Hex Cold Lappato  
33x48,3 cm - 13"x19"



Carrara Pure + Nero Marquina

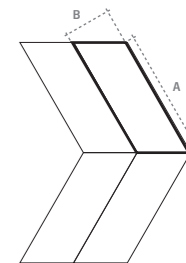

A 26,4 cm - 10<sup>3</sup>/<sub>8</sub>"  
B 9,6 cm - 3<sup>3</sup>/<sub>4</sub>"

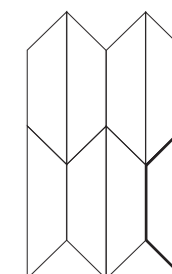

32,1x8 cm  
12<sup>5</sup>/<sub>8</sub>"x3<sup>1</sup>/<sub>8</sub>"

**MOSAICO LAPPATO**

Marvel Carrara Pure Mosaico Lappato  
30x30 cm - 11<sup>3</sup>/<sub>4</sub>"x11<sup>3</sup>/<sub>4</sub>"

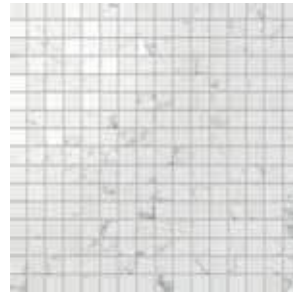

Marvel Bianco Dolomite Mosaico Lappato  
30x30 cm - 11<sup>3</sup>/<sub>4</sub>"x11<sup>3</sup>/<sub>4</sub>"

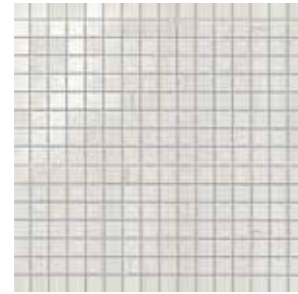

Marvel Cream Prestige Mosaico Lappato  
30x30 cm - 11<sup>3</sup>/<sub>4</sub>"x11<sup>3</sup>/<sub>4</sub>"

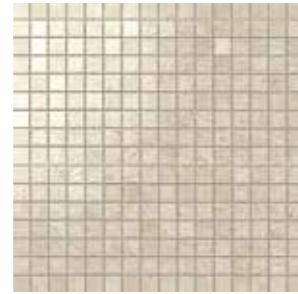

Marvel Bardiglio Grey Mosaico Lappato  
30x30 cm - 11<sup>3</sup>/<sub>4</sub>"x11<sup>3</sup>/<sub>4</sub>"

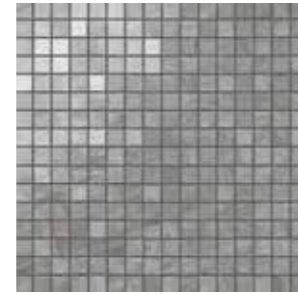

Marvel Nero Marquina Mosaico Lappato  
30x30 cm - 11<sup>3</sup>/<sub>4</sub>"x11<sup>3</sup>/<sub>4</sub>"

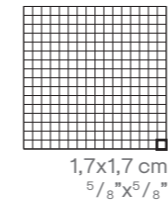
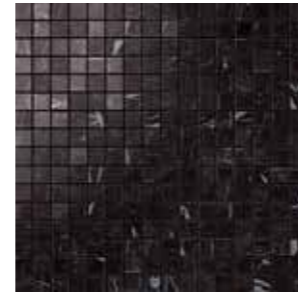

**MOSAICO LAPPATO BURATTATO**

Marvel Carrara Pure Mosaico Lappato Burattato  
29,8x29,8 cm - 11<sup>3</sup>/<sub>4</sub>"x11<sup>3</sup>/<sub>4</sub>"



Marvel Bianco Dolomite Mosaico Lappato Burattato  
29,8x29,8 cm - 11<sup>3</sup>/<sub>4</sub>"x11<sup>3</sup>/<sub>4</sub>"



Marvel Cream Prestige Mosaico Lappato Burattato  
29,8x29,8 cm - 11<sup>3</sup>/<sub>4</sub>"x11<sup>3</sup>/<sub>4</sub>"



Marvel Bardiglio Grey Mosaico Lappato Burattato  
29,8x29,8 cm - 11<sup>3</sup>/<sub>4</sub>"x11<sup>3</sup>/<sub>4</sub>"

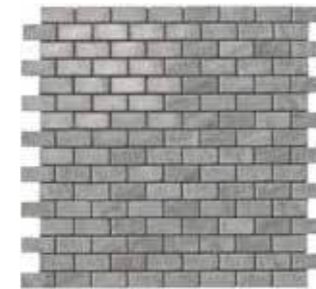

Marvel Nero Marquina Mosaico Lappato Burattato  
29,8x29,8 cm - 11<sup>3</sup>/<sub>4</sub>"x11<sup>3</sup>/<sub>4</sub>"



**MOSAICO MATT**

Marvel Carrara Pure Mosaico Matt  
30x30 cm - 11<sup>3</sup>/<sub>4</sub>"x11<sup>3</sup>/<sub>4</sub>"

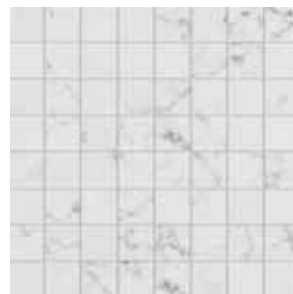

Marvel Bianco Dolomite Mosaico Matt  
30x30 cm - 11<sup>3</sup>/<sub>4</sub>"x11<sup>3</sup>/<sub>4</sub>"

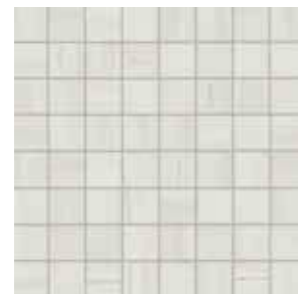

Marvel Cream Prestige Mosaico Matt  
30x30 cm - 11<sup>3</sup>/<sub>4</sub>"x11<sup>3</sup>/<sub>4</sub>"



Marvel Bardiglio Grey Mosaico Matt  
30x30 cm - 11<sup>3</sup>/<sub>4</sub>"x11<sup>3</sup>/<sub>4</sub>"



Marvel Nero Marquina Mosaico Matt  
30x30 cm - 11<sup>3</sup>/<sub>4</sub>"x11<sup>3</sup>/<sub>4</sub>"



**LISTELLO LAPPATO**

Marvel Carrara Pure Listello Lappato  
7x60 cm - 2<sup>3</sup>/<sub>4</sub>"x23<sup>5</sup>/<sub>8</sub>"



Marvel Bardiglio Grey Listello Lappato  
7x60 cm - 2<sup>3</sup>/<sub>4</sub>"x23<sup>5</sup>/<sub>8</sub>"



Marvel Bianco Dolomite Listello Lappato  
7x60 cm - 2<sup>3</sup>/<sub>4</sub>"x23<sup>5</sup>/<sub>8</sub>"



Marvel Nero Marquina Listello Lappato  
7x60 cm - 2<sup>3</sup>/<sub>4</sub>"x23<sup>5</sup>/<sub>8</sub>"



Marvel Cream Prestige Listello Lappato  
7x60 cm - 2<sup>3</sup>/<sub>4</sub>"x23<sup>5</sup>/<sub>8</sub>"



**ANGOLO LAPPATO**

Marvel Carrara Pure Angolo Lappato  
7x7 cm - 2<sup>3</sup>/<sub>4</sub>"x2<sup>3</sup>/<sub>4</sub>"



Marvel Bardiglio Grey Angolo Lappato  
7x7 cm - 2<sup>3</sup>/<sub>4</sub>"x2<sup>3</sup>/<sub>4</sub>"



Marvel Bianco Dolomite Angolo Lappato  
7x7 cm - 2<sup>3</sup>/<sub>4</sub>"x2<sup>3</sup>/<sub>4</sub>"



Marvel Nero Marquina Angolo Lappato  
7x7 cm - 2<sup>3</sup>/<sub>4</sub>"x2<sup>3</sup>/<sub>4</sub>"



Marvel Cream Prestige Angolo Lappato  
7x7 cm - 2<sup>3</sup>/<sub>4</sub>"x2<sup>3</sup>/<sub>4</sub>"



**TRIM TILES**

Marvel Scalino Angolare Sx ✓  
33x33 cm - 13"x13"

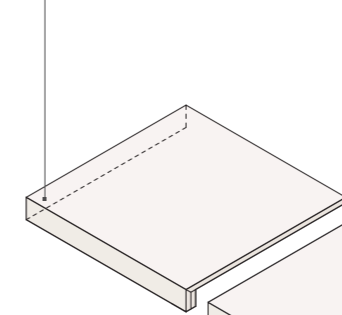

Marvel Scalino 60 ✓  
33x60 cm - 13"x23<sup>5</sup>/<sub>8</sub>"

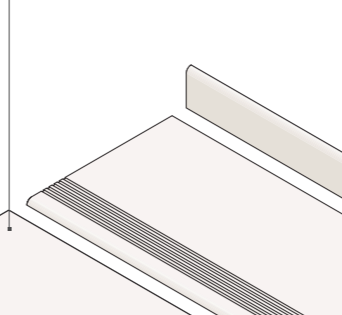

Marvel Battiscopa Matt \*  
Marvel Battiscopa Lappato \*  
7,2x60 cm - 2<sup>7</sup>/<sub>8</sub>"x23<sup>5</sup>/<sub>8</sub>"



Marvel Battiscopa Digitale Matt \*  
Marvel Battiscopa Digitale Lappato \*  
4,6x60 cm - 1<sup>3</sup>/<sub>4</sub>"x23<sup>5</sup>/<sub>8</sub>"



Marvel Gradino ✓  
30x60 cm - 11<sup>3</sup>/<sub>4</sub>"x23<sup>5</sup>/<sub>8</sub>"

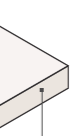

Marvel Scalino Angolare Dx ✓  
33x33 cm - 13"x13"

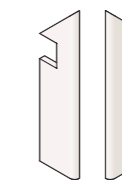

Marvel Battiscopa Sag. Scala Dx / Sx ✓  
7,2x30 cm - 2<sup>7</sup>/<sub>8</sub>"x11<sup>3</sup>/<sub>4</sub>"

\* Available in all colours  
Disponibile in tutti i colori  
Disponible dans toutes les couleurs  
In allen Faben Verfügbar  
Disponibles en todos los colores  
Имеются все цвета

✓ These parts are supplied to order  
I pezzi sono disponibili su ordinazione  
Les pièces sont disponibles sur commande  
Die Teile sind auf Bestellung lieferbar  
Las piezas se hacen por encargo  
Изготавливаются на заказ



Marvel Clauzetto White 110  
50x110 cm - 19<sup>5</sup>/<sub>8</sub>"x43<sup>1</sup>/<sub>4</sub>"



Marvel Clauzetto White 80  
40x80 cm - 15<sup>3</sup>/<sub>4</sub>"x31<sup>1</sup>/<sub>2</sub>"



Marvel Clauzetto White Spigolo  
0,8x20 cm - 3<sup>1</sup>/<sub>8</sub>"x7<sup>7</sup>/<sub>8</sub>"

Spigolo A.E.  
0,8x0,8 cm - 3<sup>1</sup>/<sub>8</sub>"x3<sup>1</sup>/<sub>8</sub>"

Marvel Desert Beige 110  
50x110 cm - 19<sup>5</sup>/<sub>8</sub>"x43<sup>1</sup>/<sub>4</sub>"



Marvel Desert Beige 80  
40x80 cm - 15<sup>3</sup>/<sub>4</sub>"x31<sup>1</sup>/<sub>2</sub>"



Marvel Desert Beige Spigolo  
0,8x20 cm - 3<sup>1</sup>/<sub>8</sub>"x7<sup>7</sup>/<sub>8</sub>"

Spigolo A.E.  
0,8x0,8 cm - 3<sup>1</sup>/<sub>8</sub>"x3<sup>1</sup>/<sub>8</sub>"

Marvel Cardoso Elegant 110  
50x110 cm - 19<sup>5</sup>/<sub>8</sub>"x43<sup>1</sup>/<sub>4</sub>"



Marvel Cardoso Elegant 80  
40x80 cm - 15<sup>3</sup>/<sub>4</sub>"x31<sup>1</sup>/<sub>2</sub>"



Marvel Cardoso Elegant Spigolo  
0,8x20 cm - 3<sup>1</sup>/<sub>8</sub>"x7<sup>7</sup>/<sub>8</sub>"

Spigolo A.E.  
0,8x0,8 cm - 3<sup>1</sup>/<sub>8</sub>"x3<sup>1</sup>/<sub>8</sub>"



Marvel 3D Plot Clauzetto White 110  
50x110 cm - 19<sup>5</sup>/<sub>8</sub>"x43<sup>1</sup>/<sub>4</sub>"



Marvel 3D Mesh Clauzetto White 80  
40x80 cm - 15<sup>3</sup>/<sub>4</sub>"x31<sup>1</sup>/<sub>2</sub>"



Marvel Clauzetto White Spigolo 10mm  
1x20 cm - 3<sup>1</sup>/<sub>8</sub>"x7<sup>7</sup>/<sub>8</sub>"

Marvel 3D Plot Desert Beige 110  
50x110 cm - 19<sup>5</sup>/<sub>8</sub>"x43<sup>1</sup>/<sub>4</sub>"



Marvel 3D Mesh Desert Beige 80  
40x80 cm - 15<sup>3</sup>/<sub>4</sub>"x31<sup>1</sup>/<sub>2</sub>"



Marvel Desert Beige Spigolo 10mm  
1x20 cm - 3<sup>1</sup>/<sub>8</sub>"x7<sup>7</sup>/<sub>8</sub>"

TUMBLLED MOSAIC

Marvel Clauzetto White Tumbled Mosaic  
30x30 cm - 11<sup>3</sup>/<sub>4</sub>"x11<sup>3</sup>/<sub>4</sub>"

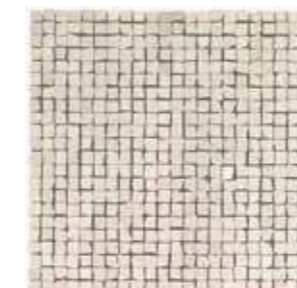

Marvel Desert Beige Tumbled Mosaic  
30x30 cm - 11<sup>3</sup>/<sub>4</sub>"x11<sup>3</sup>/<sub>4</sub>"



Marvel Cardoso Elegant Tumbled Mosaic  
30x30 cm - 11<sup>3</sup>/<sub>4</sub>"x11<sup>3</sup>/<sub>4</sub>"

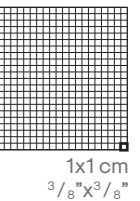

**MATT SURFACE**   

120x240 cm - 47<sup>1</sup>/<sub>4</sub>"x94<sup>1</sup>/<sub>2</sub>"



120x120 cm - 47<sup>1</sup>/<sub>4</sub>"x47<sup>1</sup>/<sub>4</sub>"



75x150 cm - 29<sup>1</sup>/<sub>2</sub>"x59"



75x75 cm - 29<sup>1</sup>/<sub>2</sub>"x29<sup>1</sup>/<sub>2</sub>"

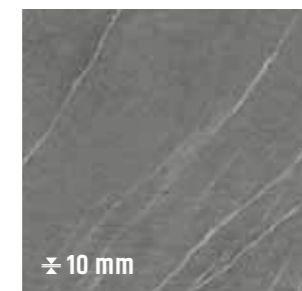

60x60 cm - 23<sup>5</sup>/<sub>8</sub>"x23<sup>5</sup>/<sub>8</sub>"

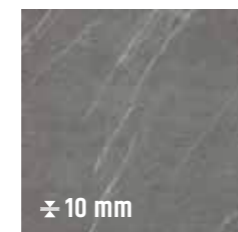

45x90 cm - 17<sup>3</sup>/<sub>4</sub>"x35<sup>3</sup>/<sub>8</sub>"



30x60 cm - 11<sup>3</sup>/<sub>4</sub>"x23<sup>5</sup>/<sub>8</sub>"



**TEXTURED SURFACE**   

30x60 cm - 11<sup>3</sup>/<sub>4</sub>"x23<sup>5</sup>/<sub>8</sub>"



**OUTDOOR PAVING**  

60x120 cm - 23<sup>5</sup>/<sub>8</sub>"x47<sup>1</sup>/<sub>4</sub>"

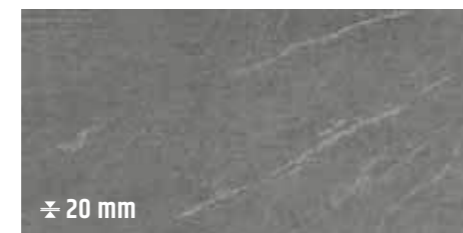

60x60 cm - 23<sup>5</sup>/<sub>8</sub>"x23<sup>5</sup>/<sub>8</sub>"

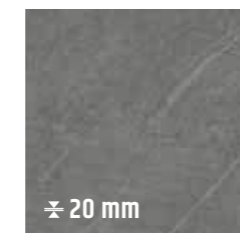

**DESTINATIONS OF USE / DESTINAZIONI D'USO**



**MEDIUM TRAFFIC**  
CALPESTIO MEDIO

MODERATE COMMERCIAL AREAS  
(restaurants, offices, showrooms, public restrooms, public offices, hotels, business lounges, etc. save for obligated pathways)

COMMERCIALI MEDI (ristoranti, uffici, negozi, bagni pubblici, uffici pubblici, hotel, business lounge, etc. a esclusione di passaggi obbligati)



**HEAVY TRAFFIC**  
CALPESTIO PESANTE

HEAVY COMMERCIAL AREAS  
(malls, airports, places of worship, schools, museums, squares, hospitals, etc.)

COMMERCIALI PESANTI (mall, aeroporti, luoghi di culto, scuole, musei, piazze, ospedali etc.)



**LASTRA 20E**

For further details on the 20 mm product, relevant trims and the installation systems, in particular for recommendations, restrictions of use, and precautions during installation, please refer to the LASTRA 20mm section on the Atlas Concorde website or to the LASTRA 20mm catalogue. / Per dettagli sul prodotto e sui relativi pezzi speciali in 20 mm di spessore, per i sistemi di posa ed, in particolare, per raccomandazioni, accorgimenti, limitazioni di utilizzo e precauzioni in fase di posa, si raccomanda di prendere visione del catalogo LASTRA 20mm e della sezione LASTRA 20mm del sito Atlas Concorde. / Pour de plus amples détails sur les produits et les pièces spéciales de 20 mm d'épaisseur et sur leurs systèmes de pose, et en particulier, pour les recommandations, mises à jour, limitations d'usage et précautions en phase de pose, veuillez prendre connaissance du catalogue LASTRA 20mm et du site Atlas Concorde LASTRA 20mm. / Für details zum produkt und formteile mit 20 mm stärke und entsprechende verlegesysteme, insbesondere hinsichtlich hinweise und anmerkungen, nutzungseinschränkungen und vorsichtsmassnahmen während der verlegung, wird die einsicht des katalogs lastra 20mm und der website atlas concorde lastra 20mm empfohlen. / Para más detalles sobre el producto y sus piezas especiales de 20 mm de espesor, para los sistemas de colocación y, en especial, para recomendaciones, límites de uso y precauciones en fase de colocación, aconsejamos consultar el catálogo LASTRA 20mm y la sección LASTRA 20mm del sitio Atlas Concorde. / Подробнее о плитках специальных элементах толщиной 20 мм, о системах монтажа, об ограничениях в применении, о мерах предосторожности при укладке можно узнать в каталоге LASTRA 20mm и в разделе LASTRA 20mm на сайте Atlas Concorde.

**MOSAICO BACCHETTA**

Marvel Clauzetto White Mosaico Bacchetta  
30x30 cm - 11<sup>3</sup>/<sub>4</sub>"x11<sup>3</sup>/<sub>4</sub>"



Marvel Desert Beige Mosaico Bacchetta  
30x30 cm - 11<sup>3</sup>/<sub>4</sub>"x11<sup>3</sup>/<sub>4</sub>"



Marvel Cardoso Elegant Mosaico Bacchetta  
30x30 cm - 11<sup>3</sup>/<sub>4</sub>"x11<sup>3</sup>/<sub>4</sub>"



Marvel Basaltina Volcano Mosaico Bacchetta  
30x30 cm - 11<sup>3</sup>/<sub>4</sub>"x11<sup>3</sup>/<sub>4</sub>"

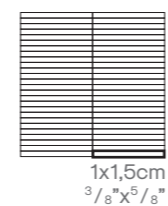

**MOSAICO BURATTATO**

Marvel Clauzetto White Mosaico Burattato  
29,8x29,8 cm - 11<sup>3</sup>/<sub>4</sub>"x11<sup>3</sup>/<sub>4</sub>"



Marvel Desert Beige Mosaico Burattato  
29,8x29,8 cm - 11<sup>3</sup>/<sub>4</sub>"x11<sup>3</sup>/<sub>4</sub>"



Marvel Cardoso Elegant Mosaico Burattato  
29,8x29,8 cm - 11<sup>3</sup>/<sub>4</sub>"x11<sup>3</sup>/<sub>4</sub>"



Marvel Basaltina Volcano Mosaico Burattato  
29,8x29,8 cm - 11<sup>3</sup>/<sub>4</sub>"x11<sup>3</sup>/<sub>4</sub>"

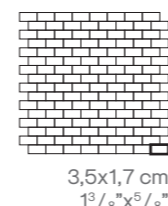

**MOSAICO**

Marvel Clauzetto White Mosaico  
30x30 cm - 11<sup>3</sup>/<sub>4</sub>"x11<sup>3</sup>/<sub>4</sub>"



Marvel Desert Beige Mosaico  
30x30 cm - 11<sup>3</sup>/<sub>4</sub>"x11<sup>3</sup>/<sub>4</sub>"

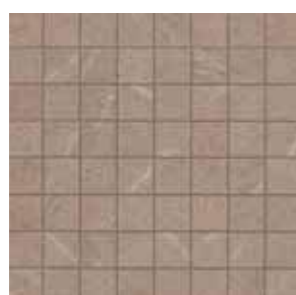

Marvel Cardoso Elegant Mosaico  
30x30 cm - 11<sup>3</sup>/<sub>4</sub>"x11<sup>3</sup>/<sub>4</sub>"

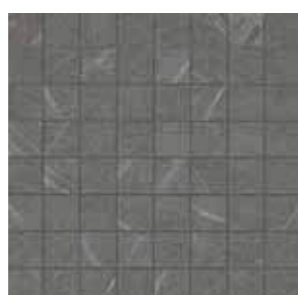

Marvel Basaltina Volcano Mosaico  
30x30 cm - 11<sup>3</sup>/<sub>4</sub>"x11<sup>3</sup>/<sub>4</sub>"

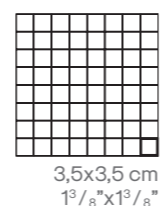

**BRICK**

Marvel Clauzetto White Brick  
30x60 cm - 11<sup>3</sup>/<sub>4</sub>"x23<sup>5</sup>/<sub>8</sub>"



Marvel Desert Beige Brick  
30x60 cm - 11<sup>3</sup>/<sub>4</sub>"x23<sup>5</sup>/<sub>8</sub>"

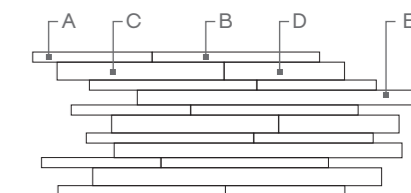

- A 2,1x24,8 cm - 3/4"x9 3/4"
- B 2,1x34,5 cm - 3/4"x13 5/8"
- C 3,3x34,5 cm - 1 3/4"x13 5/8"
- D 3,3x24,8 cm - 1 3/4"x9 3/4"
- E 2,5x60 cm - 1"x23 5/8"

Marvel Cardoso Elegant Brick  
30x60 cm - 11<sup>3</sup>/<sub>4</sub>"x23<sup>5</sup>/<sub>8</sub>"



Marvel Basaltina Volcano Brick  
30x60 cm - 11<sup>3</sup>/<sub>4</sub>"x23<sup>5</sup>/<sub>8</sub>"



**BRICK 3D**

Marvel Clauzetto White Brick 3D  
30x59 cm - 11<sup>3</sup>/<sub>4</sub>"x23 1/4"

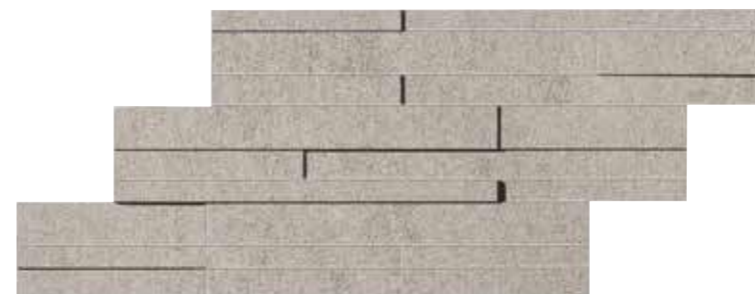

Marvel Desert Beige Brick 3D  
30x59 cm - 11<sup>3</sup>/<sub>4</sub>"x23 1/4"

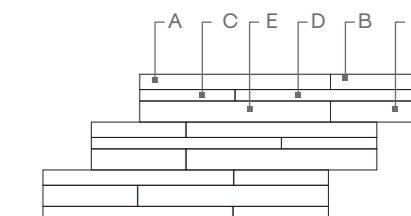

- A 3,1x39,5 cm - 1 1/4"x15 1/2"
- B 3,1x19,5 cm - 1 1/4"x7 7/8"
- C 2,3x19,5 cm - 7/8"x7 7/8"
- D 2,3x39,5 cm - 7/8"x15 1/2"
- E 4,5x39,5 cm - 1 3/4"x15 1/2"
- F 4,5x19,5 cm - 1 3/4"x7 7/8"

Marvel Cardoso Elegant Brick 3D  
30x59 cm - 11<sup>3</sup>/<sub>4</sub>"x23 1/4"



Marvel Basaltina Volcano Brick 3D  
30x59 cm - 11<sup>3</sup>/<sub>4</sub>"x23 1/4"



**LISTELLO MATT**

Marvel **Clauzetto White Listello**  
7x60 cm - 2<sup>3</sup>/<sub>4</sub>"x23<sup>5</sup>/<sub>8</sub>"



Marvel **Cardoso Elegant Listello**  
7x60 cm - 2<sup>3</sup>/<sub>4</sub>"x23<sup>5</sup>/<sub>8</sub>"



Marvel **Desert Beige Listello**  
7x60 cm - 2<sup>3</sup>/<sub>4</sub>"x23<sup>5</sup>/<sub>8</sub>"



Marvel **Basaltina Volcano Listello**  
7x60 cm - 2<sup>3</sup>/<sub>4</sub>"x23<sup>5</sup>/<sub>8</sub>"



**COLOUR-SHADING LEGEND**

 <b>V1</b> <b>Uniform appearance</b> Aspetto uniforme Aspect uniforme Gleichmäßiges Erscheinungsbild Aspecto uniforme Однородный вид	 <b>V2</b> <b>Slight variation</b> Variazione minima Variation minimale Leichte Abweichung Variación mínima Минимальная Неоднородность	 <b>V3</b> <b>Moderate variation</b> Variazione moderata Variation Modérée Mäßige Abweichung Variación moderada Умеренная Неоднородность	 <b>V4</b> <b>Substantial variation</b> Variazione sostanziale Variation substantielle Grundlegende Abweichung Variación sustancial Значительная Неоднородность
--	---	---	---

**NOTES**

For information and details relating to codes, packaging and weight it is recommended to refer to the latest pricelist / Per le informazioni e i dati relativi a codici, imballaggi e pesi occorre sempre consultare l'ultimo listino aggiornato e in vigore. / Pour toutes informations et renseignements concernant les codes, les emballages et les poids, il y a toujours lieu de consulter le dernier tarif en vigueur et mis à jour / Für Informationen und Daten die den Code, die Verpackung und das Gewicht betreffen bitte die aktuellste Preisliste zugrunde legen / Para acceder a la información y a los datos relativos a códigos, embalajes y pesos hay que consultar siempre la última lista de precios actualizada y vigente / Для информации о кодах, упаковках и весе обращайтесь к последнему действующему прайс-листу.

Colours and optical features of the materials illustrated in this catalogue are to be regarded as mere indications / I colori e le caratteristiche estetiche dei materiali illustrati nel presente catalogo sono da ritenersi puramente indicativi / Les coloris et les caractéristiques esthétiques des références illustrées dans le catalogue sont donnés à titre purement indicatif / Die Farben und die ästhetischen Eigenschaften der in diesem Katalog abgebildeten Produkte sind als reine Richtwerte zu betrachten / Los colores y las características estéticas de los materiales ilustrados en el presente catálogo deben ser considerados como puramente indicativos. / Цвета и эстетические характеристики описанных в настоящем каталоге материалов являются только ориентировочными.

Atlas Concorde reserves the right to modify any product without notice and will not be liable for any direct or indirect damage resulting from such modifications / Atlas Concorde si riserva di modificare i prodotti senza preavviso, declinando ogni responsabilità su eventuali danni diretti o indiretti derivanti da eventuali modifiche / Atlas Concorde se réserve le droit de modifier ses produits sans préavis et décline toute responsabilité concernant les éventuels dommages directs ou indirects qui pourraient dériver de ces modifications / Atlas Concorde behält sich das Recht vor jederzeit und ohne vorherige Ankündigung, die Produkte zu verändern, und lehnt jede Haftung bei direkten oder indirekten Schäden ab, die von diesen Veränderungen herrühren / Atlas Concorde se reserva el derecho de modificar los productos sin previo aviso, rechaza cualquier responsabilidad sobre eventuales daños directos o indirectos derivados de eventuales modificaciones / Atlas Concorde оставляет за собой право изменять характеристики изделий без предварительного уведомления, отклоняя при этом любую ответственность за прямые или косвенные убытки, возникшие в результате изменений.

**TRIM TILES**

**INDOOR TRIM TILES**

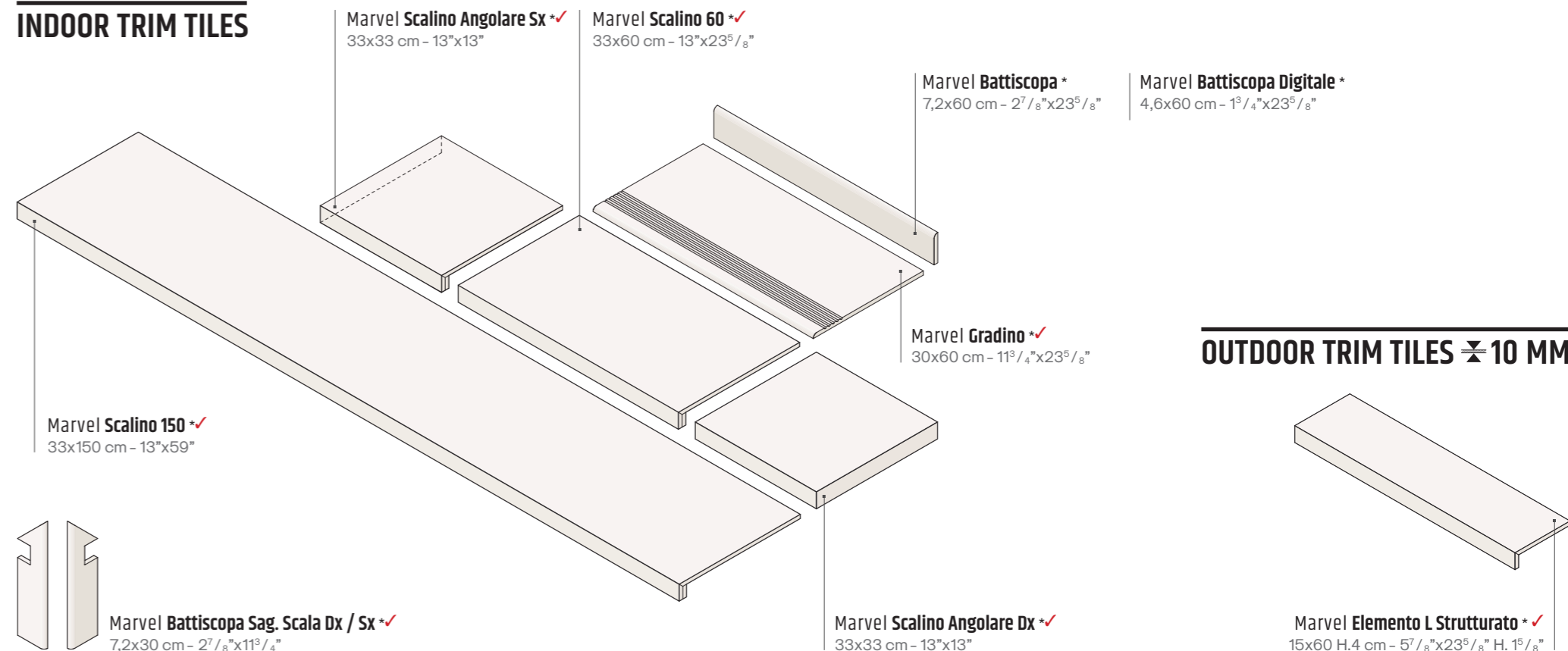

**OUTDOOR TRIM TILES ≅ 10 MM**

**OUTDOOR TRIM TILES ≅ 20 MM**

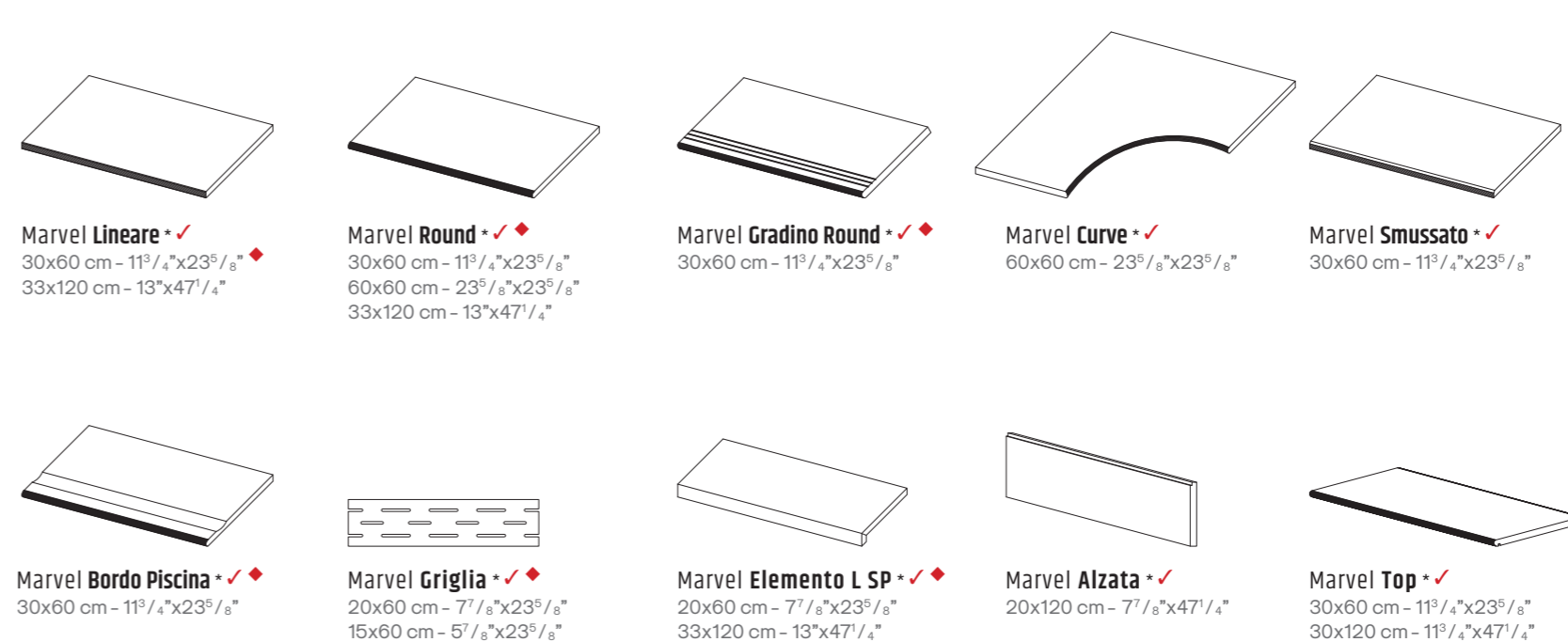

\* Available in all colours  
Disponibile in tutti i colori  
Disponible dans toutes les couleurs  
In allen Farben Verfügbar  
Disponibles en todos los colores  
Имеются все цвета

✓ These parts are supplied to order  
I pezzi sono disponibili su ordinazione  
Les pièces sont disponibles sur commande  
Die Teile sind auf Bestellung lieferbar  
Las piezas se hacen por encargo  
Изготавливаются на заказ

◆ Right/left angular elements are available / Sono disponibili gli elementi angolari dx/sx / Les éléments d'angle de droite et de gauche sont disponibles / Sind mit entsprechenden Eckelementen rechts/links erhältlich / Disponen de los elementos angulares der./izq. correspondientes. / Доступны правый и левый угловые элементы.



### White Body wall tiles - Rectified monocaliber

Compliant with standards EN 14411:2012 annex L group BIII  
Compliant with standards ISO 13006:2012 annex L group BIII  
Conforme alla norma EN 14411:2012 Appendice L gruppo BIII  
Conforme alla norma ISO 13006:2012 Appendice L gruppo BIII

### Rivestimenti in pasta bianca - Rettificato monocalibro

50x110 cm 19 7/8"x43 1/4" ± 8,5 mm  
40x80 cm 15 3/4"x31 1/2" ± 8,5 mm  
50x110 cm 19 7/8"x43 1/4" ± 11 mm 3D Plot  
40x80 cm 15 3/4"x31 1/2" ± 10 mm 3D Mesh

Technical features Caratteristiche tecniche	Test Method Metodo di prova	Requirements for nominal size N Requisiti per dimensione nominale N			
		7 cm ≤ N < 15 cm (mm)	N ≥ 15 cm (%) (mm)		
 Length and width Lunghezza e larghezza	ISO 10545-2	± 0,75 (*)	± 0,5 (*)	± 2,0 (*)	
		 Thickness Spessore	± 0,5 (**)	± 10 (**)	± 0,5 (**)
		 Straightness of sides Rettilineità degli spigoli	± 0,5 (***)	± 0,3 (***)	± 1,5 (***)
		 Rectangularity Ortogonalità	± 0,75 (****)	± 0,5 (****)	± 2,0 (****)
 Surface flatness Planarità	ISO 10545-2	c.c. + 0,75 - 0,50	c.c. + 0,5 - 0,3	c.c. + 2,0 - 1,5	
		e.c. + 0,75 - 0,50	e.c. + 0,5 - 0,3	e.c. + 2,0 - 1,5	
		w. ± 0,75	w. ± 0,5	w. ± 2,0	

Structural Characteristics Caratteristiche Strutturali	Water absorption (in% by mass) Massa d'acqua assorbita (come % della massa)	ISO 10545-3	Average >10%. When the average > 20%, this shall be indicated. Individual value > 9% Media >10%. Se questo valore > 20%, deve essere indicato. Valore Singolo > 9%
---	--	-------------	---

Bulk Mechanical Characteristics Caratteristiche Meccaniche Massive	Breaking strength Sforzo di rottura	ISO 10545-4	S ≥ 600 N
	 Modulus of rupture Resistenza alla flessione		R ≥ 15 N/mm²

Thermal and Igmometric Characteristics Caratteristiche Termo-Igrometriche	 Coefficient of thermal linear expansion Coefficiente di dilatazione termica lineare	ISO 10545-8	Declared value Dichiarare un valore	Test method available Metodo di prova disponibile
	 Thermal shock resistance Resistenza agli sbalzi termici	ISO 10545-9	Declared value Dichiarare un valore	Test method available Metodo di prova disponibile
	 Moisture expansion (in mm/m) Dilatazione all'umidità (in mm/m)	ISO 10545-10	Declared value Dichiarare un valore	Test method available Metodo di prova disponibile
	 Crazing resistance Resistenza al cavillo	ISO 10545-11	Pass according to EN ISO 10545-1 Test superato in accordo con ISO 10545-1	Required Metodo di prova richiesto

Physical Properties Proprietà fisiche	 Bond strength/adhesion for improved cementitious adhesives Adesione a trazione con adesivi cementizi migliorati	EN 1348	Declared value Dichiarare un valore	-
	 Reaction to fire Reazione al fuoco	-	Class A1 or A1 <sub>fl</sub> Classe A1 oppure A1 <sub>fl</sub>	-

Chemical Characteristics Caratteristiche Chimiche	 Resistance to household chemicals and swimming pool salts Resistenza ai prodotti chimici di uso domestico ed agli additivi per piscina	ISO 10545-13	Minimum Class B (GB for glazed tiles) Classe minima B (GB per piastrelle smaltate)	
	 Resistance to low concentrations of acids and alkalis Resistenza a basse concentrazioni di acidi e alcali		Declared Class Dichiarare una Classe	Test method available Metodo di prova disponibile
	 Resistance to high concentrations of acids and alkalis Resistenza ad alte concentrazioni di acidi e alcali	Declared Class Dichiarare una Classe	Test method available Metodo di prova disponibile	
	 Resistance to staining for glazed tiles Resistenza alle macchie piastrelle smaltate	ISO 10545-14	Minimum Class 3 Classe 3 minima	
	 Release of dangerous substances: Cadmium (in mg/dm²) and Lead (in mg/dm²) Rilascio di sostanze pericolose: Cadmio (in mg/dm²) e Piombo (in mg/dm²)	ISO 10545-15	Declared value Dichiarare un valore	Test method available Metodo di prova disponibile

(\*) The permissible deviation, in % or mm, of the average size for each tile (2 or 4 sides) from work size (W). Deviazione ammissibile, in % oppure mm, della dimensione media di ogni piastrella (2 oppure 4 lati) dalla dimensione di fabbricazione (W).  
(\*\*) The permissible deviation, in % or mm, of the average thickness for each tile from the work size thickness (W). Deviazione ammissibile, in % oppure mm, dello spessore medio di ogni piastrella dallo spessore riportato nella dimensione di fabbricazione (W).  
(\*\*\*) The maximum permissible deviation from straightness, in % or mm, related to the corresponding work sizes (W). Deviazione massima ammissibile di rettilineità, in % oppure mm, in rapporto alle dimensioni di fabbricazione (W) corrispondenti.  
(\*\*\*\*) The maximum permissible deviation from rectangularity, in % or mm, related to the corresponding work sizes (W). Deviazione massima ammissibile di ortogonalità, in % oppure mm, in rapporto alle dimensioni di fabbricazione (W) corrispondenti.  
c.c. The maximum permissible deviation from centre curvature, in % or mm, related to diagonal calculated from the work sizes (W). Deviazione massima ammissibile della curvatura del centro, in % oppure mm, in rapporto alla diagonale calcolata secondo le dimensioni di fabbricazione (W).  
e.c. The maximum permissible deviation from edge curvature, in % or mm, related to the corresponding work sizes (W). Deviazione massima ammissibile della curvatura dello spigolo, in % oppure mm, in rapporto alle dimensioni di fabbricazione (W) corrispondenti.  
w. The maximum permissible deviation from warpage, in % or mm, related to diagonal calculated from the work sizes (W). Deviazione massima ammissibile dello svergolamento, in % oppure mm, in rapporto alla diagonale calcolata secondo le dimensioni di fabbricazione (W).

MARVEL STONE Wall design	
± 0,3% ± 1,0 mm	3D Not applicable Non applicabile
± 10,0% ± 0,5 mm	
± 0,3% ± 0,8 mm	
± 0,3% ± 1,5 mm	
± 8,5 mm ± 1,5 mm	

Structural Characteristics Caratteristiche Strutturali	Water absorption (in% by mass) Massa d'acqua assorbita (come % della massa)	ISO 10545-3	E <sub>a</sub> ≤ 0,5% Individual Maximum 0,6% E <sub>3</sub> ≤ 0,5% Valore massimo singolo 0,6%		
Bulk Mechanical Characteristics Caratteristiche Meccaniche Massive	 Breaking strength Sforzo di rottura	ISO 10545-4	S ≥ 1300 N		
			R ≥ 35 N/mm²		
Surface mechanical Characteristics Caratteristiche meccaniche superficiali	 Mohs hardness Durezza Mohs	EN 101 <sup>(1)</sup>	≥ 6 (UGL)		
		 Resistance to deep abrasion of unglazed tiles (removed volume) Resistenza all'abrasione profonda delle piastrelle non smaltate (volume materiale asportato)	ISO 10545-6	≤ 175 mm³	
Thermal and Igmometric Characteristics Caratteristiche Termo-Igrometriche	 Coefficient of thermal linear expansion Coefficiente di dilatazione termica lineare	ISO 10545-8	Declared value Dichiarare un valore	Test method available Metodo di prova disponibile	
		 Thermal shock resistance Resistenza agli sbalzi termici	ISO 10545-9	Pass according to EN ISO 10545-1 Test superato in accordo con ISO 10545-1	Test method available Metodo di prova disponibile
	 Moisture expansion (in mm/m) Dilatazione all'umidità (in mm/m)	ISO 10545-10	Declared value Dichiarare un valore	Test method available Metodo di prova disponibile	
	 Frost resistance Resistenza al gelo	ISO 10545-12	Pass according to EN ISO 10545-1 Test superato in accordo con ISO 10545-1	Required Metodo di prova richiesto	
Physical Properties Proprietà fisiche	 Bond strength/adhesion for improved adhesives Adesione a trazione con adesivi cementizi migliorati	EN 1348	Declared value Dichiarare un valore	-	
		 Reaction to fire Reazione al fuoco	-	Class A1 or A1 <sub>fl</sub> Classe A1 oppure A1 <sub>fl</sub>	-
Chemical Characteristics Caratteristiche Chimiche	 Resistance to household chemicals and swimming pool salts Resistenza ai prodotti chimici di uso domestico ed agli additivi per piscina	ISO 10545-13	Minimum Class B (UB for unglazed tiles) Classe minima B (UB per piastrelle non smaltate)		
			 Resistance to low concentrations of acids and alkalis Resistenza a basse concentrazioni di acidi e alcali	Declared Class Dichiarare una Classe	Manufacturer is to state classification Secondo la classificazione indicata dal fabbricante
			 Resistance to high concentrations of acids and alkalis Resistenza ad alte concentrazioni di acidi e alcali	Declared Class Dichiarare una Classe	Test method available Metodo di prova disponibile
	 Resistance to staining for glazed tiles Resistenza alle macchie piastrelle smaltate	ISO 10545-14	Declared Class Dichiarare una Classe	Test method available Metodo di prova disponibile	
	 Release of dangerous substances: Cadmium (in mg/dm²) and Lead (in mg/dm²) Rilascio di sostanze pericolose: Cadmio (in mg/dm²) e Piombo (in mg/dm²)	ISO 10545-15	Declared value Dichiarare un valore	Test method available Metodo di prova disponibile	

(\*) The permissible deviation, in % or mm, of the average size for each tile (2 or 4 sides) from work size (W). Deviazione ammissibile, in % oppure mm, della dimensione media di ogni piastrella (2 oppure 4 lati) dalla dimensione di fabbricazione (W).  
(\*\*) The permissible deviation, in % or mm, of the average thickness for each tile from the work size thickness (W). Deviazione ammissibile, in % oppure mm, dello spessore medio di ogni piastrella dallo spessore riportato nella dimensione di fabbricazione (W).  
(\*\*\*) The maximum permissible deviation from straightness, in % or mm, related to the corresponding work sizes (W). Deviazione massima ammissibile di rettilineità, in % oppure mm, in rapporto alle dimensioni di fabbricazione (W) corrispondenti.  
(\*\*\*\*) The maximum permissible deviation from rectangularity, in % or mm, related to the corresponding work sizes (W). Deviazione massima ammissibile di ortogonalità, in % oppure mm, in rapporto alle dimensioni di fabbricazione (W) corrispondenti.  
c.c. The maximum permissible deviation from centre curvature, in % or mm, related to diagonal calculated from the work sizes (W). Deviazione massima ammissibile della curvatura del centro, in % oppure mm, in rapporto alla diagonale calcolata secondo le dimensioni di fabbricazione (W).  
e.c. The maximum permissible deviation from edge curvature, in % or mm, related to the corresponding work sizes (W). Deviazione massima ammissibile della curvatura dello spigolo, in % oppure mm, in rapporto alle dimensioni di fabbricazione (W) corrispondenti.  
w. The maximum permissible deviation from warpage, in % or mm, related to diagonal calculated from the work sizes (W). Deviazione massima ammissibile dello svergolamento, in % oppure mm, in rapporto alla diagonale calcolata secondo le dimensioni di fabbricazione (W).  
(1). Requirements european standard EN 176. Requisiti richiesti normativa europea EN 176.  
(2). Determination of slip resistance of pedestrian surfaces; it does not cover sports surfaces and road surfaces for vehicles (skid resistance). Determinazione della resistenza allo scivolamento delle superfici pedonali; non si applica alle pavimentazioni sportive ed alle pavimentazioni stradali veicolari.



### Coloured body porcelain tiles - Rectified monocaliber

Compliant with standards EN 14411:2012 annex G group BII  
Compliant with standards ISO 13006:2012 annex G group BII  
Conforme alla norma EN 14411:2012 Appendice G gruppo BII  
Conforme alla norma ISO 13006:2012 Appendice G gruppo BII

### Gres porcellanato colorato in massa - Rettificato monocalibro

120x240 cm 47 1/4"x94 1/2" ± 9 mm  
120x120 cm 47 1/4"x47 1/4" ± 9 mm  
75x150 cm 29 1/2"x59" ± 10 mm  
75x75 cm 29 1/2"x29 1/2" ± 10 mm  
45x90 cm 17 3/4"x35 3/4" ± 10 mm  
60x60 cm 23 3/4"x23 3/4" ± 10 mm  
30x60 cm 11 3/4"x23 3/4" ± 10 mm  
60x120 cm 23 3/4"x47 1/4" ± 20 mm  
60x60 cm 23 3/4"x23 3/4" ± 20 mm

Technical features Caratteristiche tecniche	Test Method Metodo di prova	Requirements for nominal size N / Requisiti per dimensione nominale N			
		7 cm ≤ N < 15 cm (mm)	N ≥ 15 cm (%) (mm)		
 Length and width Lunghezza e larghezza	ISO 10545-2	± 0,9 (*)	± 0,6 (*)	± 2,0 (*)	
		 Thickness Spessore	± 0,5 (**)	± 5 (**)	± 0,5 (**)
		 Straightness of sides Rettilineità degli spigoli	± 0,75 (****)	± 0,5 (****)	± 1,5 (****)
		 Rectangularity (Measurement only on short edges when L/1 ≥ 3) Ortogonalità (Misurazione da condurre solo sui lati corti quando L/1 ≥ 3)	± 0,75 (****)	± 0,5 (****)	± 2,0 (****)
 Surface flatness Planarità	ISO 10545-2	c.c. ± 0,75	c.c. ± 0,5	c.c. ± 2,0	
		e.c. ± 0,75	e.c. ± 0,5	e.c. ± 2,0	
		w. ± 0,75	w. ± 0,5	w. ± 2,0	

Structural Characteristics Caratteristiche Strutturali	Water absorption (in% by mass) Massa d'acqua assorbita (come % della massa)	ISO 10545-3	E <sub>a</sub> ≤ 0,5% Individual Maximum 0,6% E <sub>3</sub> ≤ 0,5% Valore massimo singolo 0,6%		
Bulk Mechanical Characteristics Caratteristiche Meccaniche Massive	 Breaking strength Sforzo di rottura	ISO 10545-4	S ≥ 1300 N		
			R ≥ 35 N/mm²		
Surface mechanical Characteristics Caratteristiche meccaniche superficiali	 Mohs hardness Durezza Mohs	EN 101 <sup>(1)</sup>	≥ 6 (UGL)		
		 Resistance to deep abrasion of unglazed tiles (removed volume) Resistenza all'abrasione profonda delle piastrelle non smaltate (volume materiale asportato)	ISO 10545-6	≤ 175 mm³	
Thermal and Igmometric Characteristics Caratteristiche Termo-Igrometriche	 Coefficient of thermal linear expansion Coefficiente di dilatazione termica lineare	ISO 10545-8	Declared value Dichiarare un valore	Test method available Metodo di prova disponibile	
		 Thermal shock resistance Resistenza agli sbalzi termici	ISO 10545-9	Pass according to EN ISO 10545-1 Test superato in accordo con ISO 10545-1	Test method available Metodo di prova disponibile
	 Moisture expansion (in mm/m) Dilatazione all'umidità (in mm/m)	ISO 10545-10	Declared value Dichiarare un valore	Test method available Metodo di prova disponibile	
	 Frost resistance Resistenza al gelo	ISO 10545-12	Pass according to EN ISO 10545-1 Test superato in accordo con ISO 10545-1	Required Metodo di prova richiesto	
Physical Properties Proprietà fisiche	 Bond strength/adhesion for improved adhesives Adesione a trazione con adesivi cementizi migliorati	EN 1348	Declared value Dichiarare un valore	-	
		 Reaction to fire Reazione al fuoco	-	Class A1 or A1 <sub>fl</sub> Classe A1 oppure A1 <sub>fl</sub>	-
Chemical Characteristics Caratteristiche Chimiche	 Resistance to household chemicals and swimming pool salts Resistenza ai prodotti chimici di uso domestico ed agli additivi per piscina	ISO 10545-13	Minimum Class B (UB for unglazed tiles) Classe minima B (UB per piastrelle non smaltate)		
			 Resistance to low concentrations of acids and alkalis Resistenza a basse concentrazioni di acidi e alcali	Declared Class Dichiarare una Classe	Manufacturer is to state classification Secondo la classificazione indicata dal fabbricante
			 Resistance to high concentrations of acids and alkalis Resistenza ad alte concentrazioni di acidi e alcali	Declared Class Dichiarare una Classe	Test method available Metodo di prova disponibile
	 Resistance to staining for glazed tiles Resistenza alle macchie piastrelle smaltate	ISO 10545-14	Declared Class Dichiarare una Classe	Test method available Metodo di prova disponibile	
	 Release of dangerous substances: Cadmium (in mg/dm²) and Lead (in mg/dm²) Rilascio di sostanze pericolose: Cadmio (in mg/dm²) e Piombo (in mg/dm²)	ISO 10545-15	Declared value Dichiarare un valore	Test method available Metodo di prova disponibile	

(\*) The permissible deviation, in % or mm, of the average size for each tile (2 or 4 sides) from work size (W). Deviazione ammissibile, in % oppure mm, della dimensione media di ogni piastrella (2 oppure 4 lati) dalla dimensione di fabbricazione (W).  
(\*\*) The permissible deviation, in % or mm, of the average thickness for each tile from the work size thickness (W). Deviazione ammissibile, in % oppure mm, dello spessore medio di ogni piastrella dallo spessore riportato nella dimensione di fabbricazione (W).  
(\*\*\*) The maximum permissible deviation from straightness, in % or mm, related to the corresponding work sizes (W). Deviazione massima ammissibile di rettilineità, in % oppure mm, in rapporto alle dimensioni di fabbricazione (W) corrispondenti.  
(\*\*\*\*) The maximum permissible deviation from rectangularity, in % or mm, related to the corresponding work sizes (W). Deviazione massima ammissibile di ortogonalità, in % oppure mm, in rapporto alle dimensioni di fabbricazione (W) corrispondenti.  
c.c. The maximum permissible deviation from centre curvature, in % or mm, related to diagonal calculated from the work sizes (W). Deviazione massima ammissibile della curvatura del centro, in % oppure mm, in rapporto alla diagonale calcolata secondo le dimensioni di fabbricazione (W).  
e.c. The maximum permissible deviation from edge curvature, in % or mm, related to the corresponding work sizes (W). Deviazione massima ammissibile della curvatura dello spigolo, in % oppure mm, in rapporto alle dimensioni di fabbricazione (W) corrispondenti.  
w. The maximum permissible deviation from warpage, in % or mm, related to diagonal calculated from the work sizes (W). Deviazione massima ammissibile dello svergolamento, in % oppure mm, in rapporto alla diagonale calcolata secondo le dimensioni di fabbricazione (W).  
(1). Requirements european standard EN 176. Requisiti richiesti normativa europea EN 176.  
(2). Determination of slip resistance of pedestrian surfaces; it does not cover sports surfaces and road surfaces for vehicles (skid resistance). Determinazione della resistenza allo scivolamento delle superfici pedonali; non si applica alle pavimentazioni sportive ed alle pavimentazioni stradali veicolari.

MARVEL STONE Floor design			
Matt	Honed	Textured	LASTRA 20mm
± 0,3% ± 1,0 mm	± 0,3% ± 1,0 mm	± 0,3% ± 1,0 mm	± 0,3% ± 1,0 mm
± 5,0% ± 0,5 mm	± 5,0% ± 0,5 mm	± 5,0% ± 0,5 mm	± 5,0% ± 0,5 mm
± 0,3% ± 0,8 mm	± 0,3% ± 0,8 mm	± 0,3% ± 0,8 mm	± 0,3% ± 0,8 mm
± 0,3% ± 1,5 mm	± 0,3% ± 1,5 mm	± 0,3% ± 1,5 mm	± 0,3% ± 1,5 mm
± 0,4% ± 1,8 mm	± 0,3% ± 1,5 mm	Not applicable to "strong" structures Non applicabile a strutturati forti	
≤ 0,1 %	≤ 0,1 %	≤ 0,1 %	≤ 0,1 %
≤ 0,5 %	≤ 0,5 %	≤ 0,5 %	≤ 0,5 %
S ≥ 1500 N	S ≥ 1500 N	S ≥ 1500 N	S ≥ 10000 N
R ≥ 40 N/mm²	R ≥ 40 N/mm²	R ≥ 40 N/mm²	R ≥ 45 N/mm²
≥ 0,55	≥ 0,55	≥ 0,55	≥ 0,55
Suitable for Conforme	5	8	8
≤ 150 mm³	≤ 150 mm³	≤ 150 mm³	≤ 150 mm³
≤ 7 MK <sup>-1</sup>	≤ 7 MK <sup>-1</sup>	≤ 7 MK <sup>-1</sup>	≤ 7 MK <sup>-1</sup>
Resistant Resiste	Resistant Resiste	Resistant Resiste	Resistant Resiste
≤ 0,01% (0,1mm/m)	≤ 0,01% (0,1mm/m)	≤ 0,01% (0,1mm/m)	≤ 0,01% (0,1mm/m)
Resistant Resiste	Resistant Resiste	Resistant Resiste	Resistant Resiste
≥ 1,0 N/mm² (Class C2 - EN 12004)	≥ 1,0 N/mm² (Class C2 - EN 12004)	≥ 1,0 N/mm² (Class C2 - EN 12004)	≥ 1,0 N/mm² (Class C2 - EN 12004)
A1 - A1 <sub>fl</sub>	A1 - A1 <sub>fl</sub>	A1 - A1 <sub>fl</sub>	A1 - A1 <sub>fl</sub>
UA	UA	UA	UA
ULA	ULA	ULA	ULA
UHA	-	UHA	UHA
5	5	5	5
A	0	A+B+C	A+B+C
R9	N.C.	R11	R11
Class 1	Class 0	Class 3	Class 3
PTV > 36 Dry PTV < 24 Wet	PTV > 36 Dry PTV < 24 Wet	PTV > 36 Dry PTV > 36 Wet	PTV > 36 Dry PTV > 36 Wet
> 0,40 Asciutto > 0,40 Bagnato	> 0,40 Asciutto > 0,40 Bagnato	> 0,40 Asciutto > 0,40 Bagnato	> 0,40 Asciutto > 0,40 Bagnato
> 0,42 Wet	< 0,42 Wet	> 0,42 Wet	> 0,42 Wet
≥ 0,60 Dry ≥ 0,60 Wet	≥ 0,60 Dry 0,50 ÷ 0,60 Wet	≥ 0,80 Dry ≥ 0,80 Wet	≥ 0,80 Dry ≥ 0,80 Wet
Class P2	Class P0	Class P3	Class P4

(\*) The permissible deviation, in % or mm, of the average size for each tile (2 or 4 sides) from work size (W). Deviazione ammissibile, in % oppure mm, della dimensione media di ogni piastrella (2 oppure 4 lati) dalla dimensione di fabbricazione (W).  
(\*\*) The permissible deviation, in % or mm, of the average thickness for each tile from the work size thickness (W). Deviazione ammissibile, in % oppure mm, dello spessore medio di ogni piastrella dallo spessore riportato nella dimensione di fabbricazione (W).  
(\*\*\*) The maximum permissible deviation from straightness, in % or mm, related to the corresponding work sizes (W). Deviazione massima ammissibile di rettilineità, in % oppure mm, in rapporto alle dimensioni di fabbricazione (W) corrispondenti.  
(\*\*\*\*) The maximum permissible deviation from rectangularity, in % or mm, related to the corresponding work sizes (W). Deviazione massima ammissibile di ortogonalità, in % oppure mm, in rapporto alle dimensioni di fabbricazione (W) corrispondenti.  
c.c. The maximum permissible deviation from centre curvature, in % or mm, related to diagonal calculated from the work sizes (W). Deviazione massima ammissibile della curvatura del centro, in % oppure mm, in rapporto alla diagonale calcolata secondo le dimensioni di fabbricazione (W).  
e.c. The maximum permissible deviation from edge curvature, in % or mm, related to the corresponding work sizes (W). Deviazione massima ammissibile della curvatura dello spigolo, in % oppure mm, in rapporto alle dimensioni di fabbricazione (W) corrispondenti.  
w. The maximum permissible deviation from warpage, in % or mm, related to diagonal calculated from the work sizes (W). Deviazione massima ammissibile dello svergolamento, in % oppure mm, in rapporto alla diagonale calcolata secondo le dimensioni di fabbricazione (W).  
(1). Requirements european standard EN 176. Requisiti richiesti normativa europea EN 176.  
(2). Determination of slip resistance of pedestrian surfaces; it does not cover sports surfaces and road surfaces for vehicles (skid resistance). Determinazione della resistenza allo scivolamento delle superfici pedonali; non si applica alle pavimentazioni sportive ed alle pavimentazioni stradali veicolari.

atlas concorde

THANKS TO

**cielo**  
handmade in Italy  
www.ceramicacielo.it

**FANTINI**  
RUBINETTI  
www.fantini.it

**Fabbian**  
www.fabbian.com

**astro**  
www.astrolighting.com

**LUCE PLAN**  
www.luceplan.com

**CEQ**  
www.ceadesign.it

il fuoco degli Dei  
www.ilfuocodegliidei.com

**DURAVIT**  
www.duravit.it

**GREEN PROJECT LEED**



www.usgbc.org/leed

COLOURED BODY PORCELAIN TILES | GRES PORCELLANATO COLORATO IN MASSA ●  
WHITE BODY WALL TILES | RIVESTIMENTI IN PASTA BIANCA ▲

The LEED standard (Leadership in Energy and Environmental Design) is a rating system dedicated to the development of "green" buildings. Developed by the US Green Building Council and internationally recognised, it points out the necessary requirements to build eco-compatible projects, capable of functioning in a sustainable and autonomous way from an energy point of view, as well as having a low environmental impact throughout their entire life cycle. This system is based on the allocation of credits for each single requirement: the total amount of credits defines the obtained certification level. Also ceramic tiles can contribute to the achievement of LEED points. Ceramiche Atlas Concorde is a member of the US Green Building Council.

Lo standard LEED (Leadership in Energy and Environmental Design) è un sistema di rating per lo sviluppo di edifici "verdi". Elaborato dall'US Green Building Council e riconosciuto a livello internazionale, indica i requisiti per costruire edifici eco-compatibili, capaci di funzionare in maniera sostenibile ed autosufficiente a livello energetico e di avere un basso impatto sull'ambiente durante tutto il loro ciclo di vita. Il sistema si basa sull'attribuzione di crediti per ciascuno dei requisiti: dalla somma dei crediti deriva il livello di certificazione ottenuto. Anche le piastrelle ceramiche possono contribuire al raggiungimento dei crediti LEED. Ceramiche Atlas Concorde è membro dell'US Green Building Council.

Le standard LEED (Leadership in Energy and Environmental Design) est un système pour l'évaluation visant au développement d'édifices écologiques. Élaboré par l'US Green Building Council, il est reconnu au niveau international et précise les critères pour construire des édifices compatibles avec l'environnement, capables de fonctionner de manière durable et autonome d'un point de vue énergétique tout en ayant un faible impact sur l'environnement durant tout leur cycle de vie. Le système se base sur l'attribution de crédits pour chacun des critères. La somme de ces crédits détermine le niveau de certification obtenu. Le carrelage en céramique peut lui aussi contribuer à obtenir des crédits LEED. Ceramiche Atlas Concorde fait partie de l'US Green Building Council.

Der LEED Standard (Leadership in Energy and Environmental Design) ist ein Bewertungssystem, das die Entwicklung "grüner" Gebäude fördert. Ausgearbeitet vom US Green Building Council ist dieser Standard international anerkannt und gibt Grundbedingungen für den Bau von öko-kompatiblen d.h. nachhaltigen und in Bezug auf Energie unabhängigen Gebäuden, die während ihres gesamten Lebenszykluses geringe Wirkung auf die Umwelt haben, vor. Das System beruht auf Credits, die man erhält, wenn diese Grundbedingungen des ökologischen Bauens erfüllt sind. Aus der Summe der Credits bestimmt sich das erreichte Zertifizierungs-niveau. Auch Fliesen können zum Erreichen der LEED Credits beitragen. Ceramiche Atlas Concorde ist Mitglied des US Green Building Council.

El estándar LEED (Leadership in Energy and Environmental Design) es un sistema de clasificación para el desarrollo de edificios "verdes". Elaborado por el US Green Building Council y reconocido a nivel internacional, indica los requisitos para construir edificios eco-compatibles, capaces de funcionar de manera sostenible y autosuficiente a nivel energético y de tener un bajo impacto ambiental durante el ciclo de vida completo. El sistema se basa en la atribución de créditos por cada uno de los requisitos: de la suma de los puntos deriva el nivel de certificación obtenido. También los azulejos cerámicos pueden contribuir al conseguimiento de los puntos LEED. Ceramiche Atlas Concorde es miembro del US Green Building Council.

LEED (Лидерство в области энергоэффективного и экологического проектирования) – признанная на международном уровне сертификационная система оценки зданий по степени экологической чистоты. Разработана Советом экологического строительства США (US Green Building Council) и устанавливает требования к проектированию и строительству зданий с точки зрения энергоэффективности, влияния на здоровье человека и окружающую среду. Система основывается на присвоении баллов по каждому из оценочных параметров, а по сумме накопленных баллов определяется уровень сертификации. Керамические плитки также могут содействовать получению баллов LEED. Ceramiche Atlas Concorde является членом Совета экологического строительства США.



▲ **RECYCLED CONTENT.** Manufactured with minimum 20% of pre-consumer recycled materials. It can contribute to the awarding of 1 LEED credit.

RECYCLED CONTENT. Contiene oltre il 20% di materiale riciclato pre-consumer e può contribuire al raggiungimento di 1 credito LEED.

RECYCLED CONTENT. Il contient plus de 20% de matériau recyclé pré-consommation et peut contribuer à l'obtention d'1 crédit LEED.

RECYCLED CONTENT. (RECYCLINGANTEIL) Enthält über 20% pre-consumer Recyclingmaterial und kann zum Erhalt von 1 LEED Punkt beitragen.

RECYCLED CONTENT. Contiene más del 20% de material reciclado de pre-consumo y puede contribuir a la obtención de 1 crédito LEED.

СОДЕРЖАНИЕ ВТОРИЧНОГО СЫРЬЯ. В производстве изделий использовано более 20% вторичного сырья, что способствует получению 1 балла LEED.

● **VOC CONTENT.** Low-emitting materials with zero emission of volatile organic compounds (VOC). It can contribute to the awarding of 1 LEED credit.

VOC CONTENT. Materiali a bassa emissione con cessione nulla di sostanze organiche volatili (VOC: "volatile organic compounds"). Può contribuire al raggiungimento di 1 credito LEED. VOC CONTENT. Matériaux à faible émission avec aucune libération de substances organiques volatiles (VOC: "volatile organic compounds"). Peut contribuer à l'obtention d'1 crédit LEED. VOC CONTENT. (VOC-GEHALT) Emissionsarme Materialien ohne Abgabe von flüchtigen organischen Verbindungen (VOC: "volatile organic compounds"). Kann zum Erhalt von 1 LEED Punkt beitragen.

VOC CONTENT. Materiales de baja emisión sin aporte de sustancias orgánicas volátiles (VOC: "volatile organic compounds"). Puede contribuir a la obtención de 1 crédito LEED. СОДЕРЖАНИЕ ЛОС. Материалы с низким или нулевым выделением летучих органических соединений (ЛОС). Содействуют получению 1 балла LEED.

● **HEAT ISLAND EFFECT.** The light colours reduce the "Heat Island Effect" in outdoor spaces. It can contribute to the awarding of 1 LEED credit.

HEAT ISLAND EFFECT. I colori chiari riducono l'effetto "isola di calore" negli spazi esterni. Può contribuire al raggiungimento di 1 credito LEED. HEAT ISLAND EFFECT. Les couleurs claires réduisent l'effet « îlot de chaleur » dans les espaces extérieurs. Peut contribuer à l'obtention d'1 crédit LEED. HEAT ISLAND EFFECT. (WÄRMEINSELEFFEKT) Die hellen Farben reduzieren den «Wärmeinsel-Effekt» in Außenbereichen. Dies kann zum Erhalt von 1 LEED Punkt beitragen. HEAT ISLAND EFFECT. Los colores claros reducen el efecto "isla de calor" en los espacios exteriores. Puede contribuir a la obtención de 1 crédito LEED. ЭФФЕКТ ТЕПЛООВОГО ОСТРОВА. Светлые цвета уменьшают эффект «теплового острова». Способствуют получению 1 балла LEED.

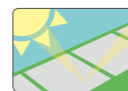

Ceramics of Italy

www.confindustriacemica.it

The Ceramics of Italy logo is an exclusive identification on ceramic products which have effectively been made in Italy by companies that are a part of the Confindustria Ceramica and who adhered to its Ethical Code. This Code, promoted and created by Confindustria Ceramica, commits all companies to communicate, clearly and with transparency, the origin of their products.

Il marchio Ceramics of Italy contrassegna esclusivamente i prodotti ceramici effettivamente realizzati in Italia da un'azienda associata a Confindustria Ceramica che ha sottoscritto il Codice Etico. Il Codice, redatto dalla stessa Confindustria Ceramica, impegna a comunicare con chiarezza l'origine dei prodotti.

MADE IN ITALY. MADE TO EXCEL.

atlas concorde

MADE IN ITALY

www.atlasconcorde.com

The Made in Italy logo of Atlas Concorde stands for style, quality and ethics. Having firmly adhered to the Ethical Code promoted by Confindustria Ceramica, Atlas Concorde places the Made in Italy logo on all the products designed and produced in Italy, that is to say ceramic tiles, decorations and the majority of special trim tiles. Only a small amount of the latter is manufactured in Spain. Atlas Concorde products are produced using eco-friendly technologies, top quality and safe raw materials with the best working conditions guaranteed for our personnel. For these reasons, Atlas Concorde's Made in Italy is the expression of strong values such as style, design, product quality, and respect for the environment and the people who live in it.

Il marchio Made in Italy di Atlas Concorde è sinonimo di stile, qualità ed etica. Avendo aderito con convinzione al Codice Etico di Confindustria Ceramica, Atlas Concorde appone il marchio Made in Italy su tutti i prodotti studiati, progettati e realizzati in Italia, nella fattispecie tutte le piastrelle di ceramica, le decorazioni e la maggioranza dei pezzi speciali. Solo un ristretto numero di questi ultimi è fabbricato in Spagna. I prodotti Atlas Concorde sono inoltre realizzati con tecnologie rispettose dell'ambiente, utilizzando materie prime eccellenti e sicure, garantendo le migliori condizioni di lavoro. Per queste ragioni il Made in Italy di Atlas Concorde è espressione di valori forti quali stile, design, qualità del prodotto, attenzione all'ambiente e alle persone.



CERAMICHE ATLAS CONCORDE S.p.A.  
Via Canaletto 141  
41042 Spezzano di Fiorano (MO) – Italia

ATLAS CONCORDE USA, Inc.  
117 Seaboard Lane - Suite 170  
Franklin, TN 37067 - USA

ATLAS CONCORDE RUSSIA  
Business centre “Meliora Place”  
Prospekt Mira 6, 129090 Moscow – Russia

**[www.atlasconcorde.com](http://www.atlasconcorde.com)**

Copyright 2016 by Ceramiche Atlas Concorde S.p.A.  
(Spezzano di Fiorano, MO - Italy)  
Tipolitografia Pagani  
August 2016