



# TRADITION

— Gres Fine Porcellanato —

★★★★★  
**MONOCIBEC**<sup>®</sup>  
FINCIBEC GROUP

# TRADITION

## concept

Tradition interpreta con stile alcuni dei materiali naturali più nobili ed eleganti, impiegati ormai da secoli per arredare finemente i luoghi della quotidianità. Tra le suggestive colorazioni spicca il calore avvolgente delle varianti Bourgogne e Travertin Beige, mentre la matericità della collezione emerge nettamente dalle sofisticate Pierre Bleue e Pierre Grise.

La bellezza naturale e senza tempo caratterizza le superfici Tradition rendendole ideali e versatili, per vestire ambienti dal gusto classico, di ispirazione moderna o dall'essenza dichiaratamente contemporanea.

La materia ceramica è plasmata con l'utilizzo delle più evolute tecnologie produttive; grazie alla vasta offerta di formati e alle tre finiture, naturale, lappata e grip, Tradition costituisce la soluzione perfetta per progettare spazi residenziali e commerciali, interni ed esterni.

Tradition is a stylish interpretation of some of our finest natural materials, used for centuries to enhance the spaces we live and work in. The striking colours include the warmth of the Bourgogne and Travertin Beige variants, while the materiality of the collection is brought out by the sophisticated Pierre Bleue and Pierre Grise.

Timeless natural beauty is the distinguishing characteristic of Tradition surfaces, whose versatility makes them ideal choices for environments inspired by classical or modern tastes, as well as for overtly contemporary preferences.

The ceramic material is worked with cutting-edge production technologies; thanks to the wide range of formats and three different finishes, natural, lapped and grip, Tradition is the perfect solution for the design of indoor and outdoor residential and business spaces.



PAG. 6

BOURGOGNE



PAG. 12

TRAVERTIN BEIGE



PAG. 18

PIERRE GRISE



PAG. 26

PIERRE BLEUE





**CERAMICA OGGI E PER SEMPRE**  
ceramics today and forever

★★★★★  
**MONOCIBEC**<sup>®</sup>  
FINCIBEC GROUP

Il gres porcellanato non teme confronti per le caratteristiche tecniche che lo rendono superiore a tutti i materiali esistenti e per le qualità estetiche che consentono la più ampia libertà espressiva. Per questo, per bellezza e per forza la ceramica è oggi la scelta vincente.



**TRANQUILLITÀ DI UN'IGIENE SICURA**  
HIGIENICALLY SAFE



**ANALLERGENICO**  
HYPOALLERGENIC



**RESISTENZA AL GELO**  
FROST RESISTANCE



**PULIBILE CON ACQUA**  
EASY TO CLEAN WITH WATER



**ECOSOSTENIBILE**  
ECO-FRIENDLY



**IMPERMEABILE**  
WATERPROOF



**RESISTENZA DEI COLORI ALLA LUCE**  
LIGHT STABILITY



**IGNIFUGO**  
FIREPROOF



**RESISTENZA ALL'ATTACCO CHIMICO**  
CHEMICAL RESISTANCE



**RESISTENZA ALLA FLESSIONE**  
FLEXION RESISTANCE



**COEFFICIENTE D'ATTRITO**  
FRICTION COEFFICIENT



**RESISTENZA ALLE MACCHIE**  
STAIN RESISTANCE

Porcelain stoneware does not fear comparisons in terms of technical characteristics that make it superior to all existing materials, and aesthetic qualities that allow the widest freedom of expression. For this reason, ceramics are currently the best choice in terms of beauty and strength.

**GRES FINE PORCELLANATO**  
Fine porcelain stoneware

# TRADITION

## colori - colours



BOURGOGNE



TRAVERTIN BEIGE



PIERRE GRISE



PIERRE BLEUE

## formati - sizes

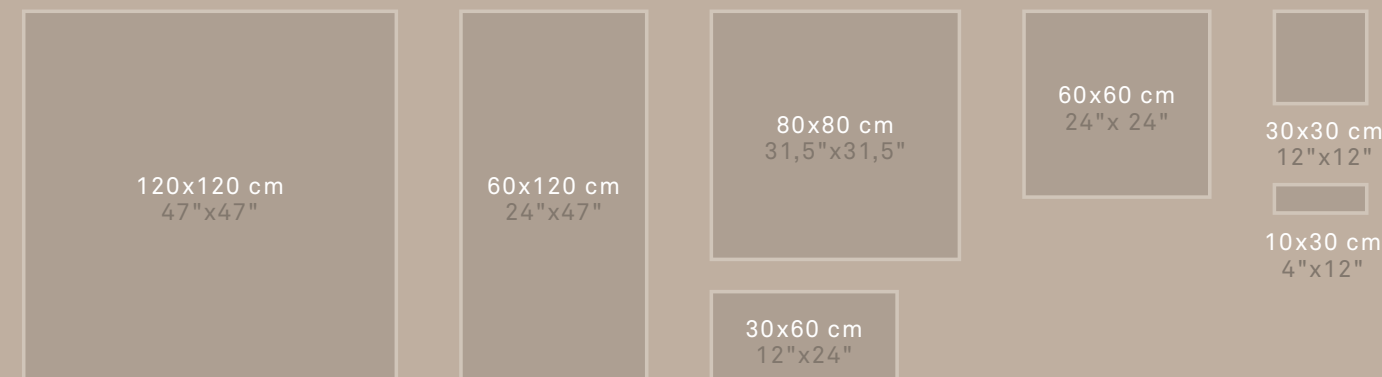

## spessore - thickness



## superfici - surfaces

### NATURALE - NATURAL

120x120 cm 47"x47"	60x120 cm 24"x47"	80x80 cm 31,5"x31,5"	60x60 cm 24"x 24"	30x60 cm 12"x24"	30x30 cm 12"x12"	10x30 cm 4"x12"
-----------------------	----------------------	-------------------------	----------------------	---------------------	---------------------	--------------------

### LAPPATA | LAPPED

120x120 cm 47"x47"	60x120 cm 24"x47"	80x80 cm 31,5"x31,5"	60x60 cm 24"x 24"	30x60 cm 12"x24"	30x30 cm 12"x12"
-----------------------	----------------------	-------------------------	----------------------	---------------------	---------------------

### GRIP | GRIP Bourgogne - Travertin Beige - Pierre Grise

60x60 cm 24"x 24"	30x60 cm 12"x24"	30x30 cm 12"x12"
----------------------	---------------------	---------------------

## bordi - edges

### NATURALE - NATURAL

10x30 cm 4"x12"
--------------------

### RETTIFICATO - RECTIFIED

120x120 cm 47"x47"	60x120 cm 24"x47"	80x80 cm 31,5"x31,5"	60x60 cm 24"x 24"	30x60 cm 12"x24"	30x30 cm 12"x12"
-----------------------	----------------------	-------------------------	----------------------	---------------------	---------------------



# BOURGOGNE

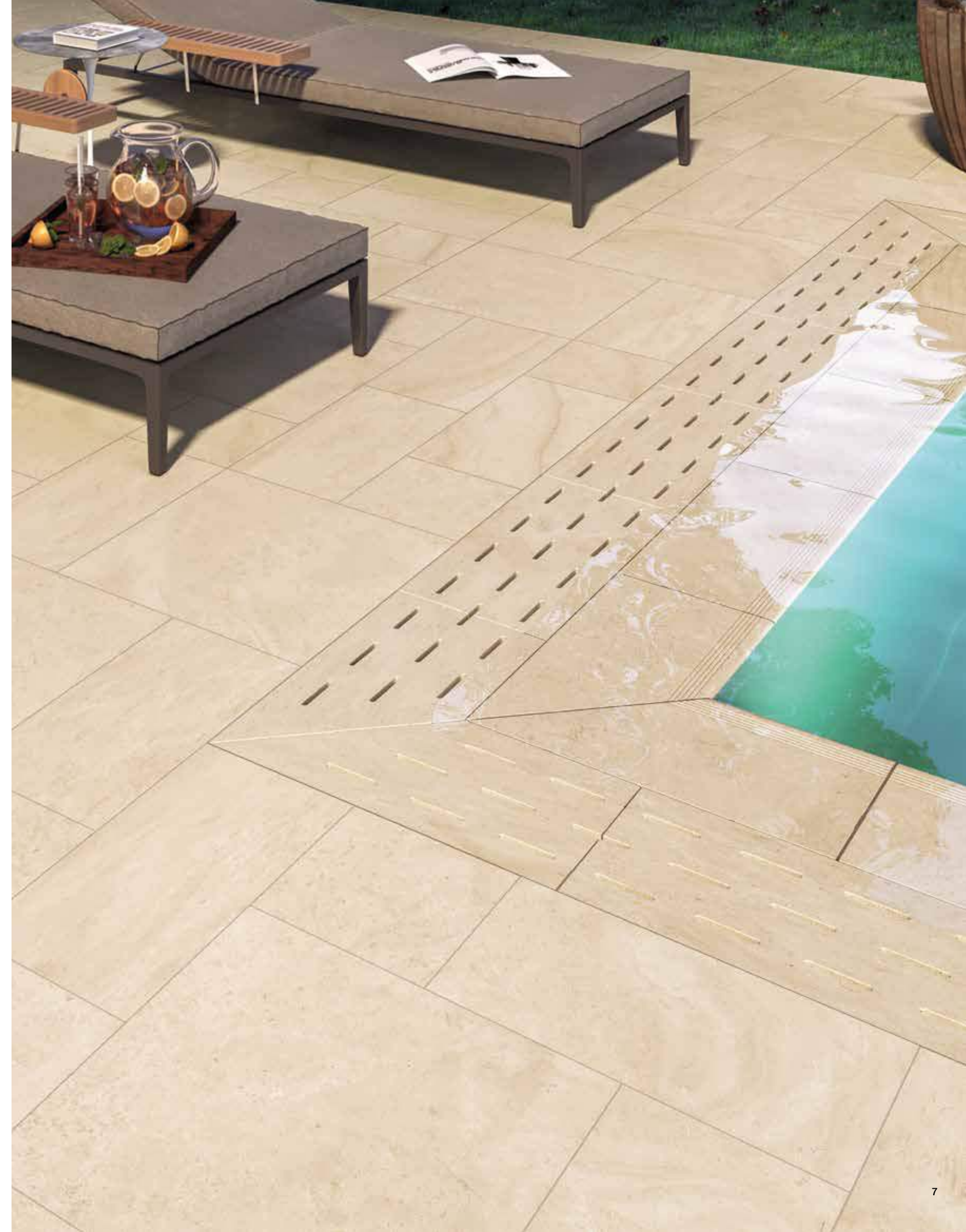





Ambiente realizzato con Tradition Bourgogne  
Setting realized with Tradition Bourgogne

80x80 cm - 31,5"x31,5" Lapp. Rett.  
60x60 cm - 24"x24" Grip Rett.  
30x60 cm - 12"x24" Grip Rett.  
30x30 cm - 12"x12" Grip Rett.



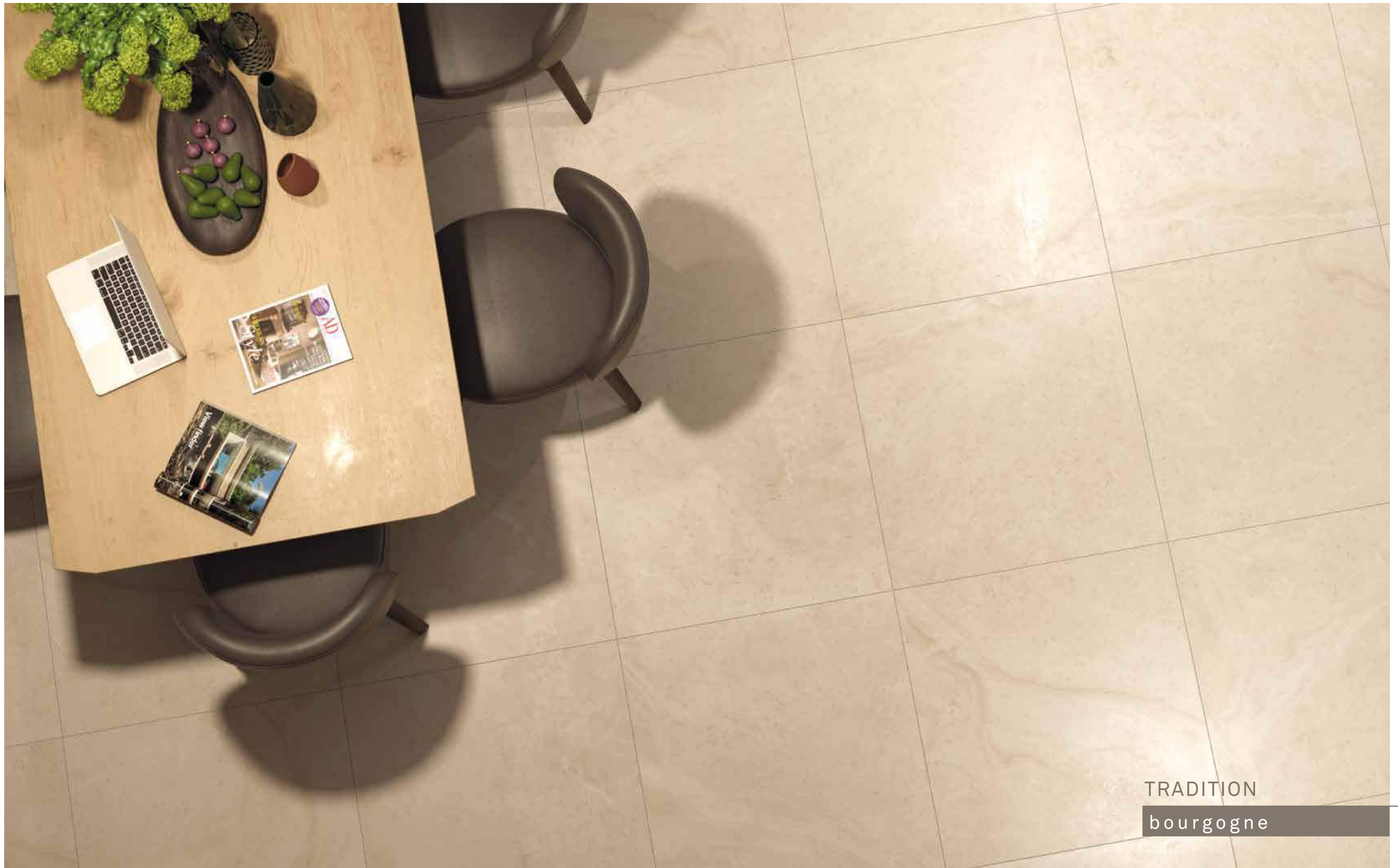

TRADITION  
bourgogne



# TRAVERTIN BEIGE







Ambiente realizzato con Tradition Travertin Beige  
Setting realized with Tradition Travertin Beige

60x120 cm - 24"x47" Lapp. Rett.  
60x60 cm - 24"x24" Lapp. Rett.  
30x60 cm - 12"x24" Lapp. Rett.  
60x60 cm - 24"x24" Grip Rett.





TRADITION  
travertin beige



# PIERRE GRISE







Ambiente realizzato con Tradition Pierre Grise  
Setting realized with Tradition Pierre Grise

120x120 cm - 47"x 47" Lapp. Rett.





TRADITION  
pierre grise





Ambiente realizzato con Tradition Pierre Grise  
Setting realized with Tradition Pierre Grise

30x30 cm - 12"x12" Grip Rett.  
30x60 cm - 12"x24" Grip Rett.  
60x60 cm - 24"x24" Grip Rett.



# PIERRE BLEUE







Ambiente realizzato con Tradition Pierre Bleue  
Setting realized with Tradition Pierre Bleue

80x80 cm - 31,5"x31,5" Nat. Rett.





TRADITION  
pierre bleue



bourgogne



120x120 cm - 47"x 47"  
**113063** Nat. Rett.  
 ■ 147  
**113069** Lapp. Rett.  
 ■ 164



60x120 cm - 24"x 47"  
**113076** Nat. Rett.  
 ■ 123  
**113081** Lapp. Rett.  
 ■ 145



80x80 cm - 31,5"x 31,5"  
**113088** Nat. Rett.  
 ■ 123  
**113177** Lapp. Rett.  
 ■ 145

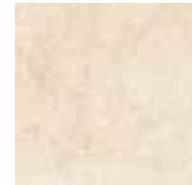

60x60 cm - 24"x 24"  
**113185** Nat. Rett.  
 ■ 105  
**113190** Lapp. Rett.  
 ■ 129  
**113797** Grip Rett.  
 ■ 105



30x60 cm - 12"x 24"  
**113198** Nat. Rett.  
 ■ 89  
**113203** Lapp. Rett.  
 ■ 111  
**113799** Grip Rett.  
 ■ 89



30x30 cm - 12"x12"  
**114987** Nat. Rett.  
 ■ 109  
**114995** Lapp. Rett.  
 ■ 129  
**114187** Grip Rett.  
 ■ 109

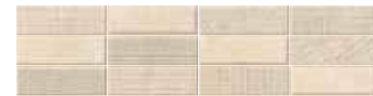

10x30 cm - 4"x12"  
 Mattoncino  
**113862** Nat.  
 ■ 159



Mosaico su rete  
 4,7x4,7 cm - 1,8"x1,8"  
 30x30 cm - 12"x12"  
**114106** Nat. Rett.  
 ■ 199



Mosaico su foglio  
 2,5x2,5 cm - 1"x 1"  
 30x30 cm - 12"x12"  
**115676** Nat. Rett.  
 ■ 222

pierre grise



120x120 cm - 47"x 47"  
**115121** Nat. Rett.  
 ■ 147  
**115122** Lapp. Rett.  
 ■ 164



60x120 cm - 24"x 47"  
**115123** Nat. Rett.  
 ■ 123  
**115124** Lapp. Rett.  
 ■ 145



80x80 cm - 31,5"x 31,5"  
**115125** Nat. Rett.  
 ■ 123  
**115126** Lapp. Rett.  
 ■ 145



60x60 cm - 24"x 24"  
**115127** Nat. Rett.  
 ■ 105  
**115143** Lapp. Rett.  
 ■ 129  
**115155** Grip Rett.  
 ■ 105



30x60 cm - 12"x 24"  
**115144** Nat. Rett.  
 ■ 89  
**115145** Lapp. Rett.  
 ■ 111  
**115177** Grip Rett.  
 ■ 89



30x30 cm - 12"x12"  
**115148** Nat. Rett.  
 ■ 109  
**115149** Lapp. Rett.  
 ■ 129  
**115322** Grip Rett.  
 ■ 109

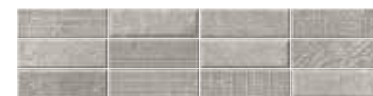

10x30 cm - 4"x12"  
 Mattoncino  
**115209** Nat.  
 ■ 159



Mosaico su rete  
 4,7x4,7 cm - 1,8"x1,8"  
 30x30 cm - 12"x12"  
**115208** Nat. Rett.  
 ■ 199



Mosaico su foglio  
 2,5x2,5 cm - 1"x 1"  
 30x30 cm - 12"x12"  
**115677** Nat. Rett.  
 ■ 222

travertin beige



120x120 cm - 47"x 47"  
**113064** Nat. Rett.  
 ■ 147  
**113072** Lapp. Rett.  
 ■ 164



60x120 cm - 24"x 47"  
**113077** Nat. Rett.  
 ■ 123  
**113084** Lapp. Rett.  
 ■ 145



80x80 cm - 31,5"x 31,5"  
**113173** Nat. Rett.  
 ■ 123  
**113178** Lapp. Rett.  
 ■ 145



60x60 cm - 24"x 24"  
**113186** Nat. Rett.  
 ■ 105  
**113191** Lapp. Rett.  
 ■ 129  
**113798** Grip Rett.  
 ■ 105



30x60 cm - 12"x 24"  
**113199** Nat. Rett.  
 ■ 89  
**113204** Lapp. Rett.  
 ■ 111  
**113800** Grip Rett.  
 ■ 89



30x30 cm - 12"x12"  
**114783** Nat. Rett.  
 ■ 109  
**114992** Lapp. Rett.  
 ■ 129  
**114188** Grip Rett.  
 ■ 109

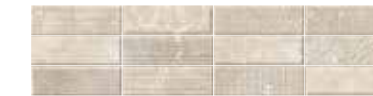

10x30 cm - 4"x12"  
 Mattoncino  
**113863** Nat.  
 ■ 159



Mosaico su rete  
 4,7x4,7 cm - 1,8"x1,8"  
 30x30 cm - 12"x12"  
**114107** Nat. Rett.  
 ■ 199



Mosaico su foglio  
 2,5x2,5 cm - 1"x 1"  
 30x30 cm - 12"x12"  
**115675** Nat. Rett.  
 ■ 222

pierre bleue



120x120 cm - 47"x 47"  
**113066** Nat. Rett.  
 ■ 147  
**113074** Lapp. Rett.  
 ■ 164



60x120 cm - 24"x 47"  
**113079** Nat. Rett.  
 ■ 123  
**113086** Lapp. Rett.  
 ■ 145



80x80 cm - 31,5"x 31,5"  
**113175** Nat. Rett.  
 ■ 123  
**113180** Lapp. Rett.  
 ■ 145

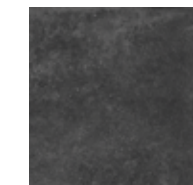

60x60 cm - 24"x 24"  
**113188** Nat. Rett.  
 ■ 105  
**113196** Lapp. Rett.  
 ■ 129



30x60 cm - 12"x 24"  
**113201** Nat. Rett.  
 ■ 89  
**113208** Lapp. Rett.  
 ■ 111



30x30 cm - 12"x12"  
**114990** Nat. Rett.  
 ■ 109  
**114996** Lapp. Rett.  
 ■ 129

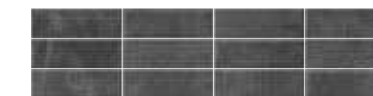

10x30 cm - 4"x12"  
 Mattoncino  
**113864** Nat.  
 ■ 159

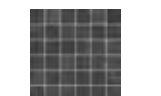

Mosaico su rete  
 4,7x4,7 cm - 1,8"x1,8"  
 30x30 cm - 12"x12"  
**114108** Nat. Rett.  
 ■ 199



# TRADITION

## pezzi speciali - special pieces

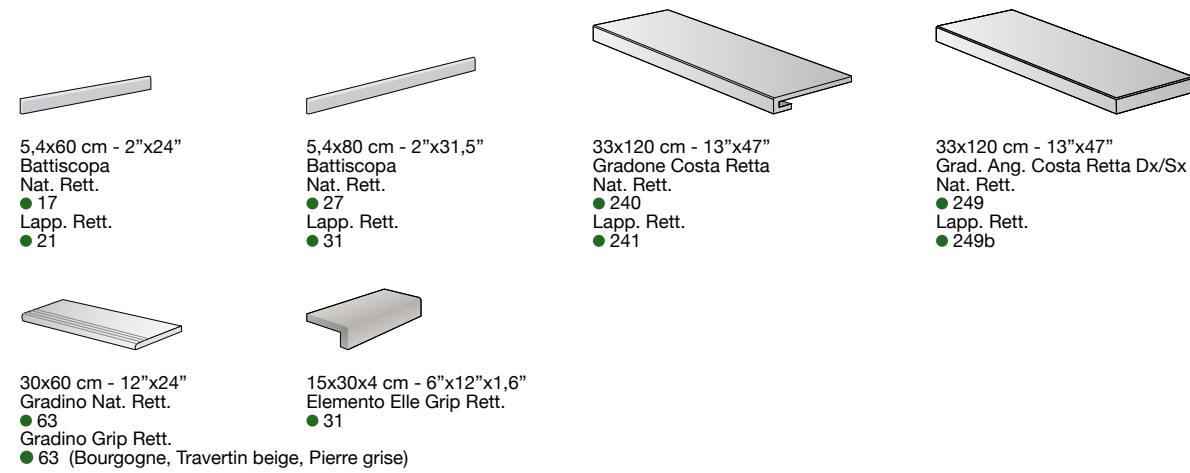

## pezzi speciali - special pieces pools&wellness



\* Prezzo per ordine minimo di 20 pezzi. Per quantitativi inferiori, rivolgersi agli uffici commerciali per una quotazione specifica.  
Price for a minimum order of 20 items. For smaller volumes, please contact our commercial office for a specific quote.

## Scivolosità - Slip resistance

	NORMA STANDARD	SUPERFICIE NATURALE NATURAL SURFACE	SUPERFICIE GRIP GRIP SURFACE	SUPERFICIE LAPPATA LAPPED SURFACE
	B.C.R.A. (D.M.I. n. 236 μ>0,4)	> 0,40	> 0,40	-
	ANSI A137.1 (DCOF WET >0,42)	> 0,42	> 0,42	> 0,42
	DIN 51130	R10	R11	-
	DIN 51097	A+B mosaico 4,7x4,7 A+B+C mosaico 2,5x2,5	A+B+C	-

PER I CERTIFICATI SPECIFICI, E VALORI PUNTUALI, CONTATTARE FINCIBEC SPA - FOR SPECIFIC CERTIFICATES AND DATA, CONTACT FINCIBEC S.P.A

## imballi - packaging

	120x120 cm 47"x47"	60x120 cm 24"x47" NAT.	60x120 cm 24"x47" LAPP.	80x80 cm 31,5"x31,5" NAT.	80x80 cm 31,5"x31,5" LAPP.	60x60 cm 24"x24"	30x60 cm 12"x 24"	30x30 cm 12"x 12"	10x30 cm 4"x12"
Pc.	2	2	2	2	2	3	6	13	30
M²	2,88	1,44	1,44	1,28	1,28	1,08	1,08	1,17	0,9
Kg	58	31	30,5	26,2	25,5	22,50	22,50	22	18,1

	120x120 cm 47"x47"	60x120 cm 24"x47" NAT.	60x120 cm 24"x47" LAPP.	80x80 cm 31,5"x31,5" NAT.	80x80 cm 31,5"x31,5" LAPP.	60x60 cm 24"x24"	30x60 cm 12"x 24"	30x30 cm 12"x 12"	10x30 cm 4"x12"
Pc.	20	35	35	40	40	40	48	48	48
M²	57,6	50,4	50,40	51,2	51,2	43,2	51,84	56,16	43,2
Kg	1160	1085	1067,5	1160	1020	900	1080	1056	868,8

## variazioni cromatiche - colours variations

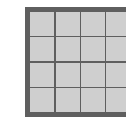

V1 Aspecto uniforme  
Even appearance

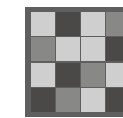

V3 Media variazione  
Medium variation

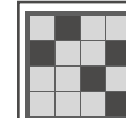

V2 Lieve variazione  
Light variation

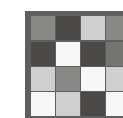

V4 Intensa variazione  
Strong variation

**È indispensabile all'atto della posa, prelevare le piastrelle da più confezioni.**

It is necessary to take the tiles from several different boxes when laying them.

## categorie d'impiego - use categories

**C1**

Piastrelle da pavimento consigliate per calpestio lieve.  
Floor tiles recommended for low traffic areas.

**C2**

Piastrelle da pavimento consigliate per calpestio leggero.  
Floor tiles recommended for light traffic areas.

**C3**

Piastrelle da pavimento consigliate per calpestio medio-leggero.  
Floor tiles recommended for medium-light traffic areas.

**C4**

**Lapp.**  
Piastrelle da pavimento consigliate per calpestio medio.  
Floor tiles recommended for medium traffic areas.

**C5**

**Grip e Nat.**  
Piastrelle da pavimento consigliate per calpestio intenso.  
Floor tiles recommended for heavy uses.

## note - notes

I prodotti possono essere modificati da Fincibec senza preavviso, respingendo ogni responsabilità su possibili danni diretti o indiretti causati da potenziali modifiche.  
Fincibec reserves the right to modify its products without prior notice and cannot be held liable for direct or indirect damage caused by such modifications.

Verificare sempre la correttezza delle informazioni e dei dati relativi a codici, imballaggi e pesi, consultando il listino prezzi in vigore. Always refer to the price list in force to ensure correct information and data on codes, packaging, and weight.

Le tonalità dei colori riportate nel catalogo sono indicative. The colours shades, reported on the catalogue, are indicative.



















## CARATTERISTICHE TECNICHE / GRES FINE PORCELLANATO COLORATO IN MASSA

TECHNICAL SPECIFICATIONS / FULL-BODY COLOURED PORCELAIN STONEWARE - TECHNISCHE EIGENSCHAFTEN / DURCHGEFÄRBTES FEINSTEINZEUG - CARACTÉRISTIQUES TECHNIQUES / GRÈS FIN CÉRAMÉ

COLORÉ EN MASSE - CARACTERÍSTICAS TÉCNICAS / GRES FINO PORCELÁNICO TEÑIDO EN MASA - ТЕХНИЧЕСКИЕ ХАРАКТЕРИСТИКИ / МЕЛКОЗЕРНИСТЫЙ КЕРАМОГРАНИТ, ОКРАШЕННЫЙ В МАССЕ

### STANDARDS : UNI EN 14411 ANNEX G - Bla / UNI EN ISO 13006 ANNEX G - Bla

	CARATTERISTICHE TECNICHE TECHNICAL DATA TECHNISCHE DATEN CARACTÉRISTIQUES TECHNIQUES CARACTERÍSTICAS TÉCNICAS ТЕХНИЧЕСКИЕ ХАРАКТЕРИСТИКИ	TIPO DI PROVA STANDARD OF TEST NORME DU TEST TESTNORM TIPO DE PRUEBA ТИП ТЕСТА	VALORI PRESCRITTI DALLE NORME INTERNATIONAL STANDARDS INTERNATIONALE NORMWERTE VALEURS PREVUES PAR LES NORMES VALORES PREVISTOS POR LAS NORMAS ПРЕДУСМОТРЕННЫЕ СТАНДАРТОМ		VALORE MEDIO MONOCIBEC MONOCIBEC AVERAGE VALUE MONOCIBEC MITTELWERT VALEURS MOYEN MONOCIBEC VALOR MEDIO MONOCIBEC СРЕДНЕЕ ЗНАЧЕНИЕ MONOCIBEC		
			REQUIREMENTS FOR NOMINAL SIZE N		NAT	LAPP.	GRIP
			7 cm ≤ N ≤ 15 cm	N ≥ 5 cm			
	<b>LATI</b> SIDES - SEITEN COTES - CANTOS РАЗМЕРЫ СТОРОН	EN ISO 10545-2	± 0,9 mm	± 0,6% (± 2,0 mm)	CONFORME COMPLYING - ERFÜLLT CONFORME - CONFORME COOBTBCTBYET		
	<b>SPESORE</b> THICKNESS - DICKE ÉPAISSEUR - ESPESOR ТОЛЩИНА	EN ISO 10545-2	± 0,5 mm	± 5,0% (± 0,5 mm)	CONFORME COMPLYING - ERFÜLLT CONFORME - CONFORME COOBTBCTBYET		
	<b>RETTILINEITÀ DEGLI SPIGOLI</b> STRAIGHTNESS OF SIDES - GERADLINIGKEIT DER KANTEN RECTITUDE DES ARÊTES - RECTITUD DE LOS CANTOS - КОСОУГОЛЬНОСТЬ	EN ISO 10545-2	± 0,75 mm	± 0,5% (± 1,5 mm)	CONFORME COMPLYING - ERFÜLLT CONFORME - CONFORME COOBTBCTBYET		
	<b>ORTOGONALITÀ</b> RECTANGULARITY - RECHTWINKLIGKEIT PERPENDICULARITÉ - ORTOGONALIDAD КРЯВИЗНА СТОРОН	EN ISO 10545-2	± 0,75 mm	± 0,5% (± 2 mm)	CONFORME COMPLYING - ERFÜLLT CONFORME - CONFORME COOBTBCTBYET		
	<b>PLANARITÀ</b> SURFACE FLATNESS - EBENFLÄCHIGKEIT PLANEITE DE SURFACE - PLANEIDAD КРЯВИЗНА ЛИЦЕВОЙ ПОВЕРХНОСТИ	EN ISO 10545-2	± 0,75 mm	± 0,5% (± 2,0 mm)	CONFORME COMPLYING - ERFÜLLT CONFORME - CONFORME COOBTBCTBYET		
	<b>ASSORBIMENTO D'ACQUA</b> WATER ABSORPTION - WASSERAUFNAHME ABSORPTION D'EAU - ABSORCIÓN DE AGUA ВОДОПОГЛОЩЕНИЕ	EN ISO 10545-3	≤ 0,5 %		≤ 0,1 %		
	<b>RESISTENZA ALLA FLESSIONE</b> FLEXION RESISTANCE - BIEGEFESTIGKEIT RESISTANCE A LA FLEXION - RESISTENCIA A LA FLEXIÓN ПРЕДЕЛ ПРОЧНОСТИ ПРИ ИЗГИБЕ	EN ISO 10545-4	S ≥ 1.300 N R ≥ 35 N/mm2.		CONFORME COMPLYING - ERFÜLLT CONFORME - CONFORME COOBTBCTBYET		
	<b>RESISTENZA ALL'URTO</b> IMPACT RESISTANCE - STOSSFESTIGKEIT RESISTANCE AUX CHOCES - RESISTENCIA A LOS GOLPES УДАРОСТОЙКОСТЬ	EN ISO 10545-5	VALORE DICHIARATO DECLARED VALUE - ANGEGEBENER WERT VALEUR DÉCLARÉE - VALOR DECLARADO - ЗАЯВЛЕННОЕ ЗНАЧЕНИЕ		> 0,80		
	<b>COEFFICIENTE DI DILATAZIONE TERMICA LINEARE</b> COEFFICIENT OF LINEAR THERMAL EXPANSION - LINEARER WÄRMESIEDEHNUNGSKOEFFIZIENT COEFFICIENT DE DILATATION THERMIQUE LINEAIRE - COEFICIENTE DE DILATACIÓN TÉRMICA LINEAL КОЭФФИЦИЕНТ ЛИНЕЙНОГО ТЕРМИЧЕСКОГО РАСТЯЖЕНИЯ	EN ISO 10545-8	VALORE DICHIARATO DECLARED VALUE - ANGEGEBENER WERT VALEUR DÉCLARÉE - VALOR DECLARADO - ЗАЯВЛЕННОЕ ЗНАЧЕНИЕ		α = 6,7 × 10 <sup>-6</sup> / °C		
	<b>RESISTENZA AGLI SBALZI TERMICI</b> RESISTANCE TO THERMAL SHOCKS - BESTÄNDIGKEIT GEGEN TEMPERATURSCHWANKUNGEN RESISTANCE AUX CHOCES THERMIQUES - RESISTENCIA A LOS CHOQUES TÉRMICOS СТОЙКОСТЬ К ПЕРЕПАДАМ ТЕМПЕРАТУРЫ	EN ISO 10545-9	TEST SUPERATO SECONDO EN ISO 10545-1 TEST PASSED ACCORDING TO - TEST BESTANDEN NACH TEXTE DÉPASSÉ SELON - PRUEBA SUPERADA SEGÚN ИСПЫТАНИЕ ПРОЙДЕНО В СООТВЕТСТВИИ С		NESSUN DANNO NO DAMAGE - KEIN SCHADEN AUCUN DOMMAGE - NINGUN DANO БЕЗ ПОВРЕЖДЕНИЙ		
	<b>DILATAZIONE ALL'UMIDITÀ (IN MM/M)</b> MOISTURE EXPANSION (IN MM/M) - FEUCHTIGKEITSBEDINGTE AUSDEHNUNG (IN MM/M) DILATATION À L'HUMIDITÉ (EN MM/M) - DILATACIÓN CON LA HUMEDAD (EN MM/M) ВЛАЖНОСТНОЕ РАСТЯЖЕНИЕ (В MM/M)	EN ISO 10545-10	VALORE DICHIARATO DECLARED VALUE - ANGEGEBENER WERT VALEUR DÉCLARÉE - VALOR DECLARADO - ЗАЯВЛЕННОЕ ЗНАЧЕНИЕ		MAX 0,1 mm / m		
	<b>RESISTENZA AL GELO</b> FROST RESISTANCE - FROSTBESTÄNDIGKEIT RESISTANCE AU GEL - RESISTENCIA AL HIELO МОРОЗОСТОЙКОСТЬ	EN ISO 10545-12	TEST SUPERATO SECONDO EN ISO 10545-1 TEST PASSED ACCORDING TO - TEST BESTANDEN NACH TEXTE DÉPASSÉ SELON - PRUEBA SUPERADA SEGÚN ИСПЫТАНИЕ ПРОЙДЕНО В СООТВЕТСТВИИ С		NESSUN DANNO NO DAMAGE - KEIN SCHADEN AUCUN DOMMAGE - NINGUN DANO БЕЗ ПОВРЕЖДЕНИЙ		
	<b>RESISTENZA AI PRODOTTI CHIMICI USO DOMESTICO E ADDITIVI PER PISCINA</b> RESISTANCE TO HOUSEHOLD AND SWIMMINGPOOL CHEMICAL PRODUCTS - RBESTÄNDIGKEIT GEGEN HAUSHALTSCHIMIKALIEN UND ZUSATZSTOFFE FÜR SWIMMINGPOOLS - RESISTENCIA AUX PRODUITS CHIMIQUES USAGE DOMESTIQUE ET ADDITIFS POUR PISCINE - RESISTENCIA A LOS PRODUCTOS QUÍMICOS DE USO DOMÉSTICO Y ADITIVOS PARA PISCINA - СТОЙКОСТЬ К ДЕЙСТВИЮ БЫТОВЫХ ХИМИЧЕСКИХ СРЕДСТВ, ДОБАВКАМ В БАССЕЙНЫ	EN ISO 10545-13	B MIN		CONFORME COMPLYING - ERFÜLLT CONFORME - CONFORME COOBTBCTBYET		
	<b>RESISTENZA A BASSE CONCENTRAZIONI DI ACIDI E ALCALI</b> RESISTANCE TO LOW CONCENTRATIONS OF ACIDS AND ALKALI - BESTÄNDIGKEIT BEI NIEDRIGEN KONZENTRATIONEN VON SÄUREN UND LAUGEN - RESISTANCE À BASSES CONCENTRATIONS D'ACIDES ET ALCALIS - RESISTENCIA A BAJAS CONCENTRACIONES DE ÁCIDOS Y ALCALIS - СТОЙКОСТЬ К ДЕЙСТВИЮ НИЗКИХ КОНЦЕНТРАЦИЙ КИСЛОТ И ЩЕЛОЧЕЙ	EN ISO 10545-13	VALORE DICHIARATO DECLARED VALUE - ANGEGEBENER WERT VALEUR DÉCLARÉE - VALOR DECLARADO - ЗАЯВЛЕННОЕ ЗНАЧЕНИЕ		CONFORME COMPLYING - ERFÜLLT CONFORME - CONFORME COOBTBCTBYET		
	<b>RESISTENZA AD ALTE CONCENTRAZIONI DI ACIDI E ALCALI</b> RESISTANCE TO HIGH CONCENTRATIONS OF ACIDS AND ALKALI - BESTÄNDIGKEIT BEI HOHEN KONZENTRATIONEN VON SÄUREN UND LAUGEN - RESISTANCE À HAUTES CONCENTRATIONS D'ACIDES ET ALCALIS - RESISTENCIA A ALTAS CONCENTRACIONES DE ÁCIDOS Y ALCALIS - СТОЙКОСТЬ К ДЕЙСТВИЮ ВЫСОКИХ КОНЦЕНТРАЦИЙ КИСЛОТ И ЩЕЛОЧЕЙ	EN ISO 10545-13	VALORE DICHIARATO DECLARED VALUE - ANGEGEBENER WERT VALEUR DÉCLARÉE - VALOR DECLARADO - ЗАЯВЛЕННОЕ ЗНАЧЕНИЕ		CONFORME COMPLYING - ERFÜLLT CONFORME - CONFORME COOBTBCTBYET		
	<b>RESISTENZA ALLE MACCHIE</b> RESISTANCE TO STAINS - FLECKENBESTÄNDIGKEIT RESISTANCE AUX TACHES - RESISTENCIA A LAS MANCHAS УСТОЙЧИВОСТЬ К ПЯТНООБРАЗОВАНИЮ	EN ISO 10545-14	VALORE DICHIARATO DECLARED VALUE - ANGEGEBENER WERT VALEUR DÉCLARÉE - VALOR DECLARADO - ЗАЯВЛЕННОЕ ЗНАЧЕНИЕ		CONFORME COMPLYING - ERFÜLLT CONFORME - CONFORME COOBTBCTBYET		
	<b>CESSIONE DI PIOMBO E CADMIO</b> LEAD AND CADMIUM DISCHARGE - ABGABE VON BLEI UND CADMIUM PERTE DE PLOMB ET CADMIUM - CESIÓN DE PLOMO Y CADMIO ВЫДЕЛЕНИЕ СВИНЦА И КАДМИЯ	EN ISO 10545-15	VALORE DICHIARATO DECLARED VALUE - ANGEGEBENER WERT VALEUR DÉCLARÉE - VALOR DECLARADO - ЗАЯВЛЕННОЕ ЗНАЧЕНИЕ		< AL LIMITE DI RILEVAMENTO < THAN INSTRUMENT LIMIT < UNMESSBARES WERT < LIMITE DE L'INSTRUMENT < LIMITE DEL INSTRUMENTO «НА ПЕРЕДЕЛЕ ОПРЕДЕЛИМОСТИ		

PER I CERTIFICATI SPECIFICI E VALORI PUNTUALI, CONTATTARE FINCIBEC SPA - FOR SPECIFIC CERTIFICATES AND DATA, CONTACT FINCIBEC S.P.A. - FÜR SPEZIELLE ZERTIFIKATE UND PUNKTWERTE, FINCIBEC S.P.A. KONTAKTIEREN - POUR LES CERTIFICATS SPÉCIFIQUES ET LES VALEURS PONCTUELLES, CONTACTER FINCIBEC S.P.A. - PARA LOS CERTIFICADOS ESPECÍFICOS Y LOS VALORES CONCRETOS, CONTACTE CON FINCIBEC S.P.A. - ВО ВОПРОСАХ СПЕЦИАЛЬНЫХ СЕРТИФИКАТОВ И ПОКАЗАТЕЛЕЙ СВЯЖИТЕСЬ С FINCIBEC SPA.

ESCLUSO PEZZI SPECIALI ED ELEMENTI DECORATIVI - WITH THE EXCEPTION OF SPECIAL PIECES AND DECORS - A L'EXCEPTION DE PIÈCES SPÉCIALES ET ÉLÉMENTS DÉCORATIFS - AUSSCHLIEBLICH FORMSTÜCKE UND DEKORTEILE

TRADITION

★★★★★  
**MONOCIBEC®**  
FINCIBEC GROUP





**MONOCIBEC**

Via Valle d'Aosta, 47 - 41049 - Sassuolo (Mo) Italy

Tel. +39 0536 861300  
Fax Italia +39 0536 861400  
Fax Export Dept. +39 0536 861450  
info@monocibec.it  
www.monocibec.it

**Fincibec S.p.A.**

Sede legale: Via Valle d'Aosta, 47 - 41049 - Sassuolo (Mo) Italy  
Gruppo Fire S.R.L.

---

**Fincibec USA Inc.**

420 Columbus Avenue, Valhalla NY 10595 - USA  
info@fincibecusa.com

FINCIBEC S.p.A. socio di:

