



STONE BOX

Real, natural, strong surface

Made in Italy



NovaBell

STONE
BOX

Made in Italy
 NovaBell

NovaBell
OutWalk

REAL, NATURAL,
STRONG SURFACE.

THICKNESS
20
MM + THICKNESS ANTELUPIA
9
MM

STONE BOX È LA NUOVA RACCOLTA DI PIETRE IN GRES PORCELLANATO NATA PER L'ESTERNO. CON QUESTO TRAGUARDO ESTETICO E TECNOLOGICO LA SUPERFICIE NOVABELL SI TRASFORMA IN UNA MATERIA INCREDIBILMENTE VERA, NATURALE, FORTE PIÙ CHE MAI.

STONE BOX EST LA NOUVELLE COLLECTION DE PIERRES EN GRÈS CÉRAME CRÉÉE POUR L'EXTÉRIEUR. GRÂCE À CETTE AVANCÉE ESTHÉTIQUE ET TECHNOLOGIQUE, LA SURFACE NOVABELL DEVIENT UN MATÉRIAU D'UN INCROYABLE RÉALISME, NATUREL, PLUS RÉSISTANT QUE JAMAIS.

STONE BOX IS THE NEW COLLECTION OF PORCELAIN STONEWARE DEVELOPED FOR OUTDOOR USE. WITH THIS AESTHETIC AND TECHNOLOGICAL ACHIEVEMENT, THE NOVABELL SURFACE HAS BEEN TRANSFORMED INTO AN INCREDIBLY REAL AND NATURAL MATERIAL THAT IS STRONGER THAN EVER.

STONE BOX IST DIE NEUE FEINSTEINZEUGSERIE IN NATURSTEINOPTIK FÜR AUSSENBEREICHE. MIT DIESEM ÄSTHETISCHEN UND TECHNOLOGISCHEN ANSPRUCH VERWANDELT SICH DIE OBERFLÄCHE VON NOVABELL IN EINE UNGLAUBLICH ECHT AUSSEHENDE, NATURLICHE UND EXTREM AUSDRUCKSSTARKE MATERIE.

STONE BOX È LA SELEZIONE DI ROCCE
PROVENIENTI DAI QUATTRO ANGOLI DEL
MONDO, TRE RIFERIMENTI ESTETICI CHE CON
LE LORO CARATTERISTICHE GEOLOGICHE
SI TRASFORMANO IN QUATTRO MATERIE
NATURALI, BELLISSIME, ETERNE.

STONE BOX IS A SELECTION OF DIFFERENT
ROCKS FROM THE FOUR CORNERS OF THE
WORLD: THREE AESTHETIC REFERENCES WHICH,
WITH THEIR GEOLOGICAL CHARACTERISTICS,
ARE TRANSFORMED INTO FOUR NATURAL,
BEAUTIFUL AND TIMELESS MATERIALS.

STONE BOX EST UNE SÉLECTION DE ROCHES
PROVENANT DES QUATRE COINS DU MONDE :
TROIS RÉFÉRENCES ESTHÉTIQUES QUI, GRÂCE
À LEURS CARACTÉRISTIQUES GÉOLOGIQUES,
DEVIENNENT QUATRE MATÉRIAUX NATURELS,
SUPERBES ET ÉTERNELS.

STONE BOX IST EINE AUSWAHL VON
NATURSTEIN AUS ALLEN TEILEN DER WELT: DREI
ÄSTHETISCHE REFERENZEN, DIE SICH MIT IHREN
GEOLOGISCHEN EIGENSCHAFTEN IN VIER
NATÜRLICHE, AUSGESPROCHEN SCHÖNE UND
ZEITLOSE MATERIEEN VERWANDELN.



WORLD STONES LOVED BY ARCHITECTS.

I FORMATI SONO STUDIATI PER ENFATIZZARE GRAFICA E COLORI; IL REALISMO, LE PERFORMANCE, I NUMEROSI ACCESSORI PER L'ESTERNO; TUTTO RACCOGLIE IL MEGLIO DELLA TECNOLOGIA INDUSTRIALE E DELLA BELLEZZA NATURALE.

LES FORMATS SONT ÉTUDIÉS POUR METTRE EN RELIEF LE GRAPHISME ET LES COULEURS; LE RÉALISME, LES PERFORMANCES, LES NOMBREUX ACCESSOIRES POUR L'EXTÉRIEUR; TOUT RASSEMBLE CE QUE LA TECHNOLOGIE INDUSTRIELLE ET LA BEAUTÉ NATURELLE ONT DE MIEUX À OFFRIR.

THE SIZES ARE DESIGNED TO ACCENTUATE PATTERNS AND COLOURS. FROM ITS REALISTIC LOOK TO ITS PERFORMANCE AND NUMEROUS OUTDOOR ACCESSORIES, THE COLLECTION BRINGS TOGETHER THE BEST OF INDUSTRIAL TECHNOLOGY AND NATURAL BEAUTY.

DIE FORMATE SIND SO AUSGELEGT, DASS DIE GRAFIK UND DIE FARBEN BESTENS ZUR GELTUNG KOMMEN; REALISMUS, PERFORMANCES UND ZAHLREICHE ZUBEHÖRTEILE FÜR DEN AUSSENBEREICH; IN ALLEM IST DIE VOLLKOMMENHEIT INDUSTRIELLER TECHNOLOGIE UND NATÜRLICHER SCHÖNHEIT ZU SPÜREN.

 **NovaBell** **NovaBell**
OutWalk

THICKNESS
20
MM



60x120
23^{5/8}x47^{1/4}



60x90
23^{5/8}x35^{7/16}

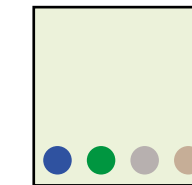

60x60
23^{5/8}x23^{5/8}



30x60
11^{13/16}x23^{5/8}

THICKNESS ANTISLIP
9
MM

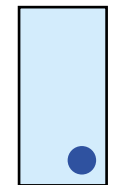

30x60
11^{13/16}x23^{5/8}

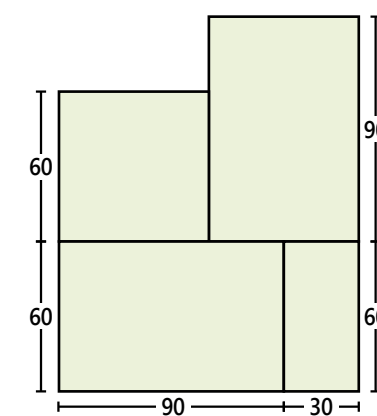

MULTISIZE ●



DOLOMIA GOLD



DOLOMIA GREY



BLUE STONE



GIAVA
MULTICOLOR

OUT
WALK

Porcelain
slabs

THICKNESS
20
MM

DOLOMIA

60x120 - 23⁵/₈x47¹/₄
60x60 - 23⁵/₈x23⁵/₈

DOLOMIA
Gold



DOLOMIA
Grey



NOVABELL HA SELEZIONATO IL MEGLIO DELLA PIETRA DI RIFERIMENTO, UNA ROCCIA SEDIMENTARIA ELEGANTE E CRISTALLINA. CON LE DUE VARIANTI CROMATICHE FREDDA E CALDA, NOVABELL RADDOPPIA L'ESPRESSIVITÀ MATERICA E LE POSSIBILITÀ DI UTILIZZO.

NOVABELL HAS SELECTED THE BEST OF THIS STONE, AN ELEGANT AND CRYSTALLINE SEDIMENTARY ROCK. WITH THE TWO COLD AND WARM COLOUR VARIANTS, NOVABELL DOUBLES THE TACTILE EXPRESSIVENESS AND POSSIBLE APPLICATIONS.

NOVABELL A SÉLECTIONNÉ LE MEILLEUR DE LA PIERRE DE RÉFÉRENCE, UNE ROCHE SÉDIMENTAIRE ÉLÉGANTE ET CRISTALLINE. AVEC LES DEUX VARIANTES DE COULEUR FROIDE ET CHAUDE, NOVABELL DOUBLE L'EXPRESSIVITÉ DU MATÉRIAU ET SES POSSIBILITÉS D'UTILISATION.

NOVABELL HAT DAS BESTE DES REFERENZ-NATURSTEINS AUSGESUCHT: ELEGANZ UND KRISTALLINE BESCHAFFENHEIT VON SEDIMENTGESTEIN. MIT DEN ZWEI FARBVARIANTEN - KALT UND WARM - VERDOPPELT NOVABELL DIE MATERIALBETONTE EXPRESSIVITÄT UND DIE EINSATZMÖGLICHKEITEN.



Floor: DOLOMIA Grey 20MM Rettificato 60x120 / 23^{5/8}x47^{1/4}

DOLOMIA Gold 20MM Rettificato 60x60 / 23^{5/8}x23^{5/8} - 60x120 / 23^{5/8}x47^{1/4} - Gradino Elle 30x60 / 11^{13/16}x23^{5/8}

Furnishing: FIORIERA BASSA 120x40x40h / 47^{1/4}x15^{3/4}x15^{3/4}



Floor: DOLOMIA Grey 20MM Rettificato 60x120 / 23^{5/8}x47^{1/4}
 DOLOMIA Gold 20MM Rettificato 60x60 / 23^{5/8}x23^{5/8} - 60x120 / 23^{5/8}x47^{1/4}
 Stairs: Gradino Elle 30x60 / 11^{13/16}x23^{5/8} - Gradino Elle 30x120 / 11^{13/16}x47^{1/4}

THICKNESS 20 MM Gradino Elle

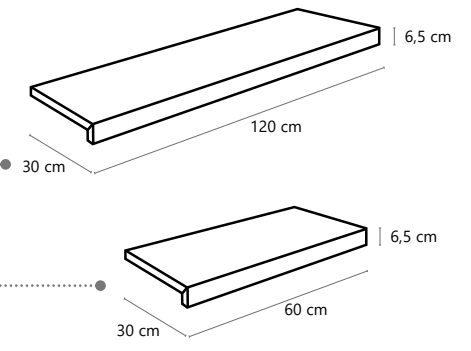

THICKNESS 20 MM Gradino L17

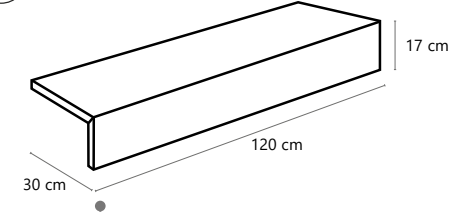

Stairs: Gradino L17 30x120x17 / 11^{13/16}x47^{1/4}x6^{11/16}

OUT
WALK

Porcelain
slabs

THICKNESS
20
MM

GIAVA MULTICOLOR

60x60 - 23⁵/₈x23⁵/₈
30x60 - 11¹³/₁₆x23⁵/₈

THICKNESS
20
MM

THICKNESS ANTISLIP
9
MM

GIAVA
Multicolor



GIAVA MULTICOLOR RAPPRESENTA LA QUARZITE DAL FASCINO ESOTICO, CON LE SUE SIGNIFICATIVE VARIAZIONI CROMATICHE DAL GRIGIO SCURO AL GIALLO OCRA. NOVABELL RESTITUISCE OGNI SFUMATURA IN UN RINNOVATO EQUILIBRIO, TRASFORMANDO LA CASUALITÀ NATURALE IN CALIBRATA E ARMONIOSA SUPERFICIE.

GIAVA MULTICOLOR REPRODUCES QUARTZITE WITH AN EXOTIC ALLURE, FEATURING SIGNIFICANT COLOUR VARIATIONS RANGING FROM DARK GREY TO YELLOW OCHRE. NOVABELL RENDERS EVERY SHADE IN A RENEWED BALANCE, TRANSFORMING NATURAL RANDOMNESS INTO A CALIBRATED AND HARMONIOUS SURFACE.

GRÂCE À SES FORTES VARIATIONS DE COULEUR ALLANT DU GRIS FONCÉ À L'OCRE JAUNE, GIAVA MULTICOLOR REPRÉSENTE LE QUARTZITE AU CHARME EXOTIQUE. NOVABELL OFFRE LE RENDU DE CHACUNE DES NUANCES DANS UN NOUVEL ÉQUILIBRE, TRANSFORMANT LE HASARD NATUREL EN SURFACE CALIBRÉE ET HARMONIEUSE.

GIAVA MULTICOLOR REPRÄSENTIERT DEN QUARZIT MIT EXOTISCHEM CHARME, DER MIT SIGNIFIKANTEN FARBVARIATIONEN VON DUNKELGRAU BIS OCKERGELB AUFWARTEN KANN. NOVABELL VERMAG ES, JEDE SCHATTIERUNG IN EIN ERNEUERTES GLEICHGEWICHT ZU BRINGEN UND DABEI DIE ZUFÄLLIGKEIT DER NATUR IN EINE KALIBRIERTE UND HARMONISCHE OBERFLÄCHE ZU VERWANDELN.



Floor: GIAVA 20MM Rettificato Multicolor 30x60 / 11^{13/16}x23^{5/8}

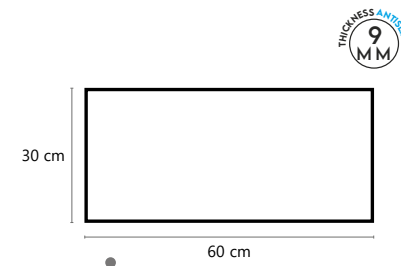

LA VERSION ANTISLIP DI SPESSORE 9 MM DI GIAVA MULTICOLOR È IDEALE PER RIVESTIRE L'INTERNO DELLE PISCINE.

THE 9 MM ANTISLIP VERSION OF MULTICOLOR GIAVA IS IDEAL FOR THE INSIDE OF SWIMMING POOLS.

LA VERSION ANTIDÉRAPANTE EN ÉPAISSEUR 9 MM DE GIAVA MULTICOLOR EST IDÉALE POUR REVÊTIR L'INTÉRIEUR DES PISCINES.

DIE 9 MM STARKE RUTSCHFESTE VERSION VON GIAVA MULTICOLOR EIGNET SICH IDEAL ZUR INNENAUSKLEIDUNG VON SWIMMINGPOOLS.

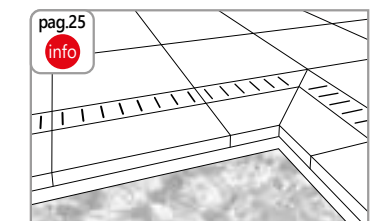
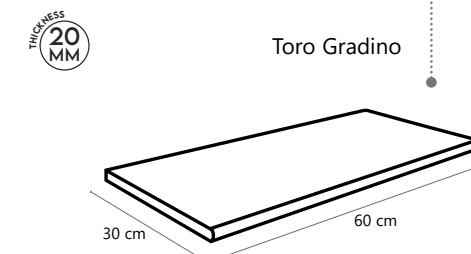

BLUE STONE

60x90 - 23⁵/₈x35⁷/₁₆
60x60 - 23⁵/₈x23⁵/₈
MULTISIZE

Blue Stone



LA MATERIA NOVABELL CONSERVA IL FASCINO EVOLUTIVO DELLA PIETRA BLUE STONE, L'ANTICA ROCCIA CALCAREA DALLE TONALITÀ PROFONDE. IL GRES PORCELLANATO STONE BOX REGALA UNA MATERIA SOBRIA E MINIMALISTA CON UNA PRESENZA GRAFICA DI FOSSILI DALL'EFFETTO LUMINOSO.

THE NOVABELL MATERIAL RETAINS THE EVOLUTIONARY CHARM OF PIETRA BLUESTONE, AN ANCIENT LIMESTONE ROCK WITH DEEP TONES. STONE BOX PORCELAIN STONEWARE OFFERS AN ELEGANT, MINIMALIST MATERIAL WITH A LUMINOUS FOSSIL EFFECT.

LE MATÉRIAU NOVABELL PRÉSERVE LE CHARME ÉVOLUTIF DE LA PIERRE BLEUE, LA PIERRE CALCAIRE ANTIQUE AUX TONALITÉS PROFONDES. LE GRÈS CÉRAME STONE BOX OFFRE UN MATÉRIAU SOBRE ET MINIMALISTE AVEC UNE PRÉSENCE GRAPHIQUE DE FOSSILES À L'EFFET LUMINEUX.

DIE NOVABELL MATERIE KONSERVIERT DEN EVOLUTIVEN CHARME DES BLAUSTEINS, EINES ANTIKEN NATURKALKSTEINS, DER SICH DURCH INTENSIVE FARBTÖNE AUSZEICHNET. DAS FEINSTEINZEUG STONE BOX BIETET NÜCHTERNE UND MINIMALISTISCHE MATERIEN MIT GRAFISCH AUFGEARBEITETEN VERSTEINERUNGEN IN LEUCHTOPTIK.





Floor: Blue Stone 20MM Rettificato MULTISIZE
 Wall: Breccia Antracite 16x40 / 6^{5/16}x15^{3/4}

Swimming Pool: Griglia Angolo DX e SX 20x60 - 7^{7/8}x23^{5/8} / Griglia Rettificato 20x60 - 7^{7/8}x23^{5/8}
 Angolo Arrotondato Toro 60x60 - 23^{5/8}x23^{5/8} / Toro Gradino 30x60x6,5 - 11^{13/16}x23^{5/8}x2^{9/16}

OUT WALK Porcelain slabs

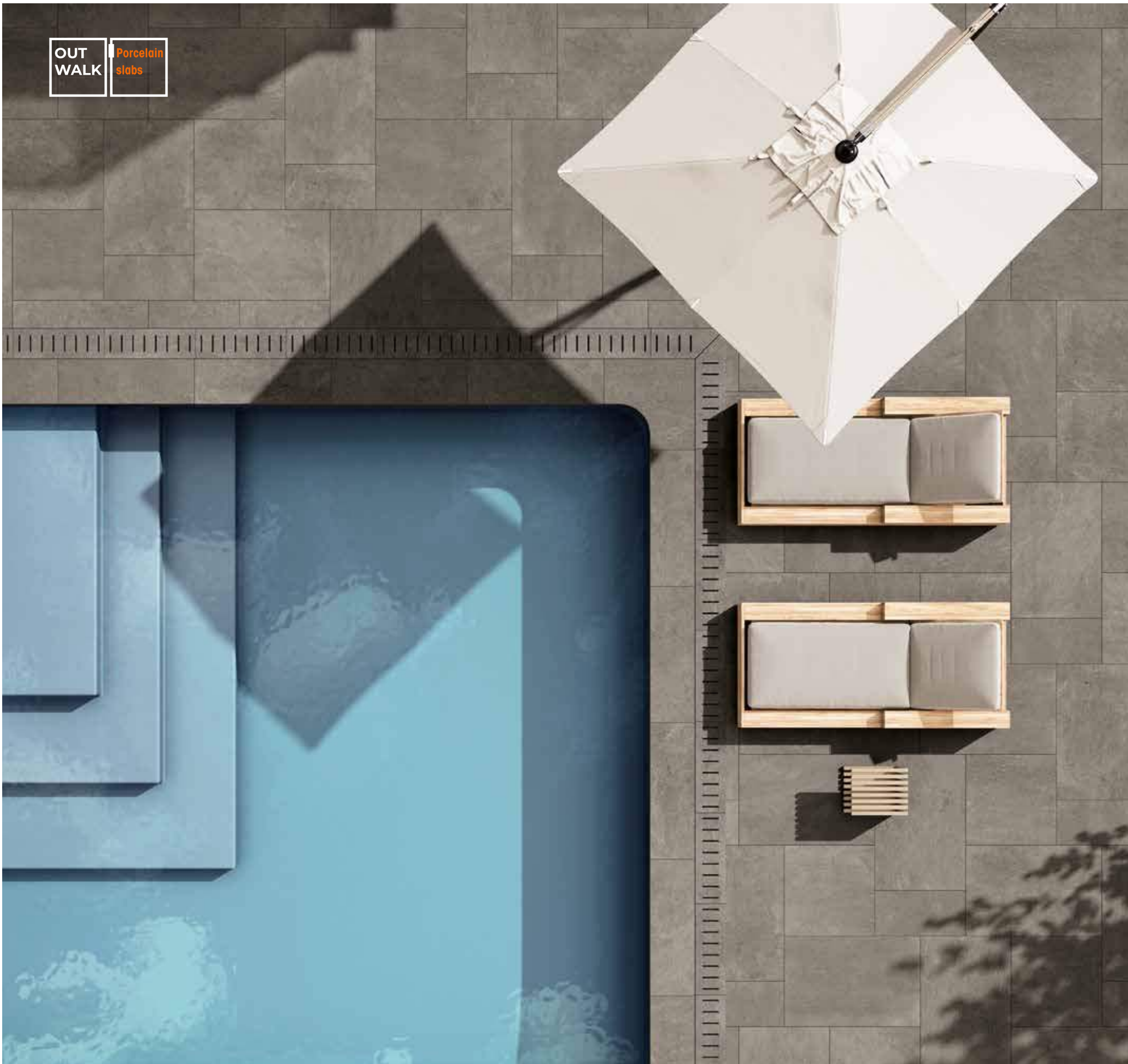

STONEBOX POSSIEDE UNA RICCA PROPOSTA DI COMPLEMENTI E PEZZI SPECIALI CREATI PER ESALTARE LE CARATTERISTICHE ESTETICHE DELLA COLLEZIONE. DETTAGLI PREZIOSI CHE ISPIRANO PROGETTI D'ARREDO ORIGINALI E SOTTOLINEANO UNA NATURALE ELEGANZA.

STONEBOX INCLUDES A RICH ASSORTMENT OF SPECIAL TRIMS AND ACCESSORY PIECES CREATED TO ENHANCE THE COLLECTION'S STYLISH LOOKS. EXQUISITE DETAILS THAT INSPIRE ORIGINAL DESIGN SCHEMES AND UNDERLINE A NATURAL ELEGANCE.

STONE BOX PROPOSE UNE OFFRE ÉTOFFÉE EN MATIÈRE DE COMPLÈMENTS ET DE PIÈCES SPÉCIALES CRÉÉS POUR EXALTER LES CARACTÉRISTIQUES ESTHÉTIQUES DE LA COLLECTION. DES DÉTAILS RAFFINÉS QUI INSPIRENT DES PROJETS DE DÉCORATION ORIGINAUX ET VIENNENT SOULIGNER UNE ÉLÉGANCE NATURELLE.

STONE BOX VERFÜGT ÜBER EIN BREIT GEFÄCHERTES SPEKTRUM AN ZUBEHÖR- UND FORMTEILEN, WELCHE DIE OPTISCHEN MERKMALE DER KOLLEKTION NOCH STÄRKER ZUR GELTUNG BRINGEN. WERTIGE DETAILS INSPIRIEREN ZU ORIGINELLEN GESTALTUNGSKONZEPTEN UND BETONEN EINE NATÜRLICHE ELEGANZ.

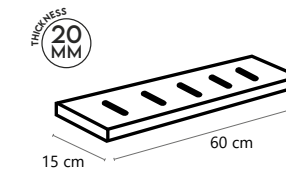

Griglia

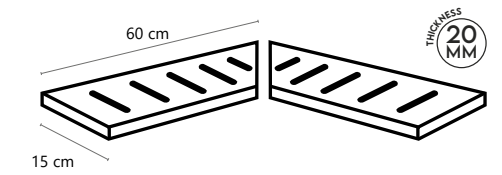

Griglia Angolo SX/DX



Toro Gradino

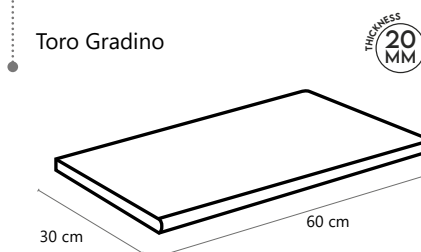

Angolo arrotondato toro

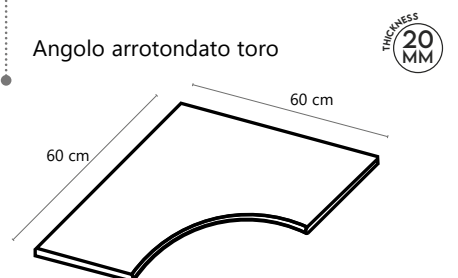

STONE BOX DOLOMIA



cm. 60x120
inch. 23⁵/₈x47¹/₄ cm. 60x60
inch. 23⁵/₈x23⁵/₈

DOLOMIA GOLD



STONE BOX BLUE STONE



cm. 60x90 cm. 60x60 MULTISIZE
inch. 23⁵/₈x35⁷/₁₆ inch. 23⁵/₈x23⁵/₈

BLUE STONE



STONE BOX 22

DOLOMIA GREY



STONE BOX GIAVA



cm. 60x60 cm. 30x60 cm. 30x60
inch. 23⁵/₈x23⁵/₈ inch. 11¹³/₁₆x23⁵/₈ inch. 11¹³/₁₆x23⁵/₈

GIAVA MULTICOLOR



23

COLOR	20 MM	
	60x120 23 ⁵ / ₈ x47 ¹ / ₄ 01 1125	60x60 23 ⁵ / ₈ x23 ⁵ / ₈ 02 1115
Dolomia Gold	SBD 462R	SBD 460R
Dolomia Grey	SBD 162R	SBD 160R

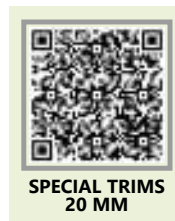
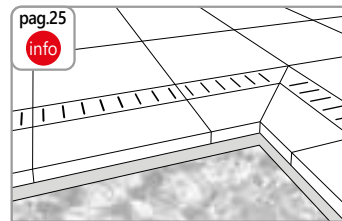

COLOR	20 MM				9 MM
	60x90 23 ⁵ / ₈ x35 ⁷ / ₁₆ 01 1120	60x60 23 ⁵ / ₈ x23 ⁵ / ₈ 02 1115	30x60 11 ¹³ / ₁₆ x23 ⁵ / ₈ 03 1115	Multisize 1cp. 1130	30x60 11 ¹³ / ₁₆ x23 ⁵ / ₈ 03 1040
Giava Multicolor	-	SBG 160R	SBG 163R	-	SBG 11AS
Blue Stone	SBP 169R	SBP 160R	-	SBP M133	-

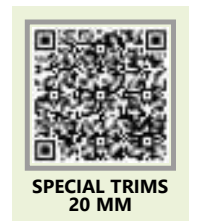

TECHNICAL	DIN EN 16165 annex B	DIN EN 16165 annex A	BCR	ANSI DCOF	Deep Abrasion Resistance	MOHS	Recommended Use	Resistance to Staining	ANSI A 137.1
ANTISLIP	R11	A+B+C	DRY > 0.40 WET > 0.40	WET ≥ 0.42	< 175 mm ³	≥ 7	5	5	
20 MM	R11	A+B+C	DRY > 0.40 WET > 0.40	WET ≥ 0.42	< 130 mm ³	≥ 8	5	5	

IMBALLI E PESI / PACKAGING AND WEIGHTS / VERPACKUNGEN UND GEWICHTE / EMBALLAGES ET POIDS

	SCATOLA / BOX			PALLET			▼ ▲
	pz	m2	kg	box	m2	kg	
30x60	7	1,260	24,4	40	50,400	977	9
60x120	1	0,720	31,5	32	23,040	1008	20
60x90	1	0,540	23,3	48	25,920	1118	20
60x60	2	0,720	31,4	32	23,040	1005	20
30x60	3	0,540	23,6	40	21,600	944	20
Multisize	1 cp.	1,620	71,7	14 cp.	22,680	1004	20

MERCHANDISING



ESP2CM60
SCALETTA 10 POSIZIONI
60X60X2



ESP2CM22
ESPOSITORE DA ESTERNO
PIETRE



ESP2CMPPOOL
ESPOSITORE DA ESTERNO
ACCESSORI PISCINA

cod. **FLD20MM2**

FOLDER OUTDOOR
FLOOR PROJECT



Accessori e pezzi speciali / Accessories and special trims

Zubehör und Sonderanfertigungen / Accessoires et pièce spéciales

PEZZI SPECIALI 20MM FINITURE STANDARD Special coordinated pieces ON DEMAND / Pièces spéciales coordonnées SUR DEMANDE/ Zusammenstellbare Formteile AUF ANFRAGE			Stone Box Blue Stone	Stone Box Dolomia	Stone Box Giava
CODICE GENERICO	DESCRIZIONE	FP			
GR EL 1217	Gradino L17 30x120x17	01 681		SBD L1217	
GR EL A27	Angolo L17 SX/DX 30x120x17	1+1 682		SBD LA27	
GR EL 1265	Gradino Elle 30x120x6,5	01 676		SBD L1265	
GR EL A12	Angolo Elle SX/DX 30x120x6,5	1+1 678		SBD LA12	
GR EL 9065	Gradino Elle 30x90x6,5	02 664	SBP L9065		
GR EL A90	Angolo Elle SX/DX 30x90x6,5	1+1 667	SBP LA90		
GR EL 6065	Gradino Elle 30x60x6,5	02 652	SBP L6065	SBD L6065	SBG L6065
GR EL A60	Angolo Elle SX/DX 30x60x6,5	1+1 656	SBP LA60	SBD LA60	SBG LA60
GR EL A30	Angolo Elle 30x30x6,5	02 625	SBP LA30	SBD LA30	SBG LA30
GR TOR 120	Toro Gradino 30x120	01 656		SBD T120	
GR TOR A12	Toro Angolo SX/DX 30x120	1+1 665		SBD TA12	
GR TOR 900	Toro Gradino 30x90	02 640	SBP T900		
GR TOR A90	Toro Angolo SX/DX 30x90	1+1 662	SBP TA90		
GR TOR 600	Toro Gradino 30x60	02 518	SBP T600		SBG T600
GR TOR A60	Toro Angolo SX/DX 30x60	1+1 627	SBP TA60		SBG TA60
3/5 RIGHE ANTIDERAPANT € 10,00 / PCS					

PEZZI SPECIALI 20MM FINITURE STANDARD Special coordinated pieces ON DEMAND / Pièces spéciales coordonnées SUR DEMANDE/ Zusammenstellbare Formteile AUF ANFRAGE			Stone Box Blue Stone	Stone Box Dolomia	Stone Box Giava
CODICE GENERICO	DESCRIZIONE	FP			
GR RET 61	GRADINO COSTA RETTA 30x60	02 607	SBP R61	SBD R61	SBG R61
GR RET A61	Angolo Arrotondato Costa Retta 60x60	01 664	SBP RA61	SBD RA61	SBG RA61
GR TOR A161	Angolo Arrotondato Toro 60x60	01 672	SBP TA61	SBD TA61	SBG TA61
GRI 260	Griglia 20x60	02 590		SBD G260	
GRI 245	Griglia 20x45	02 590	SBP G245		
GRI 156	Griglia 15x60	02 520			SBG G156
GRI A260	Griglia Angolo SX/DX 20x60	1+1 610		SBD GA260	
GRI A245	Griglia Angolo SX/DX 20x45	1+1 610	SBP GA245		
GRI A156	Griglia Angolo SX/DX 15x60	1+1 540			SBG GA156

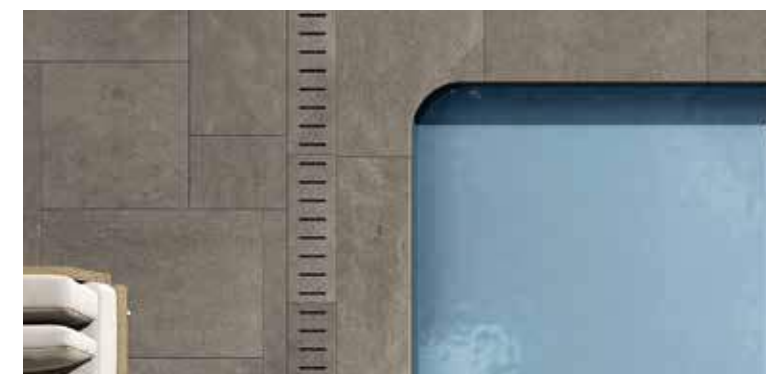

DATI TECNICI / Technical features

Technische eigenschaften / Caracteristiques techniques



**STONE BOX
20 MM**



**STONE BOX
9 MM ANT.**

Utilizzare il **QR CODE** per scaricare le schede tecniche

Use the **QR CODE** to download data sheets

Veuillez utiliser le **QR CODE** pour télécharger les fiches techniques

QR CODE benutzen um die technische datenblätter runter zu laden

LEED® CERTIFICATION COMPLIANT

STONE BOX E' UN PRODOTTO CON PARTICOLARI CARATTERISTICHE DI ECOSOSTENIBILITA', CHE CONTRIBUISCE ALL'OTTENIMENTO DEI CREDITI PER LA CERTIFICAZIONE LEED (LEADERSHIP IN ENERGY AND ENVIROMENTAL DESIGN).

STONE BOX IS A PRODUCT WITH PARTICULAR ENVIRONMENTAL SUSTAINABILITY CHARACTERISTICS, THAT HELPS IN OBTAINING POINTS FOR LEED (LEADERSHIP IN ENERGY AND ENVIRONMENTAL DESIGN) CERTIFICATION.

STONE BOX IST EIN AUSGESPROCHEN UMWELTFREUNDLICHES PRODUKT, DAS ZUM ERREICHEN DER PUNKTE FÜR DIE ZERTIFIZIERUNG NACH LEED (LEADERSHIP IN ENERGY AND ENVIROMENTAL DESIGN) BEITRÄGT.

LA SERIE STONE BOX PRESENTE DE CARACTERISTIQUES SPECIFIQUES DE DEVELOPPEMENT DURABLE; ELLE CONTRIBUS A OBTENIR DE CREDITS POUR LA CERTIFICATION LEED (LEADERSHIP IN ENERGY AND ENVIROMENTAL DESIGN).





CAT-SBX

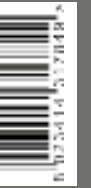

NOVABELL SpA CERAMICHE ITALIANE
via Molino, 1 - 42014 Roteglia (RE), Italia
T +39 0536 86 11 11 - F +39 0536 85 12 05
info@novabell.it - export@novabell.it
www.novabell.it

